

UC-8100 Series Hardware User's Manual

Version 4.0, September 2020

www.moxa.com/product



© 2020 Moxa Inc. All rights reserved.

UC-8100 Series Hardware User's Manual

The software described in this manual is furnished under a license agreement and may be used only in accordance with the terms of that agreement.

Copyright Notice

© 2020 Moxa Inc. All rights reserved.

Trademarks

The MOXA logo is a registered trademark of Moxa Inc.
All other trademarks or registered marks in this manual belong to their respective manufacturers.

Disclaimer

Information in this document is subject to change without notice and does not represent a commitment on the part of Moxa.

Moxa provides this document as is, without warranty of any kind, either expressed or implied, including, but not limited to, its particular purpose. Moxa reserves the right to make improvements and/or changes to this manual, or to the products and/or the programs described in this manual, at any time.

Information provided in this manual is intended to be accurate and reliable. However, Moxa assumes no responsibility for its use, or for any infringements on the rights of third parties that may result from its use.

This product might include unintentional technical or typographical errors. Changes are periodically made to the information herein to correct such errors, and these changes are incorporated into new editions of the publication.

Technical Support Contact Information

www.moxa.com/support

Moxa Americas

Toll-free: 1-888-669-2872
Tel: +1-714-528-6777
Fax: +1-714-528-6778

Moxa Europe

Tel: +49-89-3 70 03 99-0
Fax: +49-89-3 70 03 99-99

Moxa India

Tel: +91-80-4172-9088
Fax: +91-80-4132-1045

Moxa China (Shanghai office)

Toll-free: 800-820-5036
Tel: +86-21-5258-9955
Fax: +86-21-5258-5505

Moxa Asia-Pacific

Tel: +886-2-8919-1230
Fax: +886-2-8919-1231

Table of Contents

1. Introduction	1-1
Overview	1-2
Model Descriptions.....	1-2
Package Checklist.....	1-2
Hardware Specifications	1-2
Hardware Block Diagram	1-3
2. Hardware Introduction	2-1
Appearance.....	2-2
LED Indicators.....	2-3
Default Programmable Button Operations	2-4
Diagnosing Device and Subsystem Failures.....	2-4
Reset to Default Button	2-5
Real Time Clock.....	2-5
Placement Options	2-5
DIN Rail Mounting	2-5
Wall or Cabinet Mounting	2-6
3. Hardware Connection Description	3-1
Wiring Requirements.....	3-2
Connecting the Power	3-2
Grounding the Unit	3-2
Connecting to the Console Port.....	3-3
Connecting to the Network.....	3-3
Connecting to a Serial Device.....	3-4
Inserting the SD and SIM Card	3-4
USB Port.....	3-4
Installing the Cellular Module	3-5
A. Regulatory Approval Statements	A-1

Introduction

The UC-8100 series computing platform is designed for embedded data acquisition applications. The computer comes with one or two RS-232/422/485 serial ports and dual 10/100 Mbps Ethernet LAN ports, as well as a Mini PCIe socket to support cellular modules. These versatile communication capabilities let users efficiently adapt the UC-8100 computers to a variety of complex communications solutions.

The following topics are covered in this chapter:

- ❑ **Overview**
- ❑ **Model Descriptions**
- ❑ **Package Checklist**
- ❑ **Hardware Specifications**
- ❑ **Hardware Block Diagram**

Overview

The UC-8100 Series is built around an Armv7 Cortex-A8 RISC processor that has been optimized for use in energy monitoring systems, but is widely applicable to a variety of industrial solutions. With flexible interfacing options, this tiny embedded computer is a reliable and secure gateway for data acquisition and processing at field sites as well as a useful communication platform for many other large-scale deployments.

Model Descriptions

The UC-8100 Series includes the following models:

- **UC-8131-LX**: RISC-based platform with 300 MHz CPU, 2 Ethernet ports, 1 serial port, 8 GB eMMC, SD socket, USB port, and Moxa Industrial Linux pre-installed
- **UC-8132-LX**: RISC-based platform with 300 MHz CPU, Mini PCIe socket for cellular/Wi-Fi module, 2 Ethernet ports, 2 serial ports, 8 GB eMMC, SD socket, USB port, and Moxa Industrial Linux pre-installed
- **UC-8162-LX**: RISC-based platform with 600 MHz CPU, Mini PCIe socket for cellular/Wi-Fi module, 2 Ethernet ports, 2 serial ports, 8 GB eMMC, SD socket, USB port, and Moxa Industrial Linux pre-installed
- **UC-8112-LX**: RISC-based platform with 1 GHz CPU, Mini PCIe socket for cellular/Wi-Fi module, 2 Ethernet ports, 2 serial ports, 8 GB eMMC, SD socket, USB port, and Moxa Industrial Linux pre-installed

Package Checklist

Before deploying the UC-8100 computer, verify that the package contains the following items:

- UC-8100 embedded computer
- Console cable
- Power jack
- 3-pin terminal block for power (Pre-installed on the UC-8100)
- 5-pin terminal block for UART x 2 (Pre-installed on the UC-8100)

NOTE: Notify your sales representative if any of the above items are missing or damaged.

Hardware Specifications

NOTE The latest specifications for Moxa's products can be found at <https://www.moxa.com>.

Hardware Block Diagram

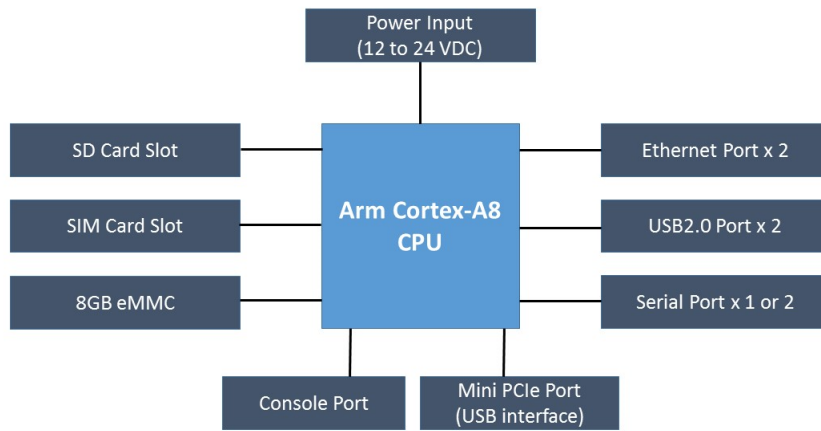

Hardware Introduction

The UC-8100 Series of embedded computers are compact and rugged, making them suitable for industrial applications. The LED indicators allow users to monitor performance and identify trouble spots quickly, and the multiple ports can be used to connect a variety of devices. The UC-8100 Series comes with a reliable and stable hardware platform that lets you devote the bulk of your time to application development. In this chapter, we provide basic information about the embedded computer's hardware and its various components.

The following topics are covered in this chapter:

- ❑ **Appearance**
- ❑ **LED Indicators**
- ❑ **Default Programmable Button Operations**
 - Diagnosing Device and Subsystem Failures
- ❑ **Reset to Default Button**
- ❑ **Real Time Clock**
- ❑ **Placement Options**
 - DIN Rail Mounting
 - Wall or Cabinet Mounting

Appearance

Front View

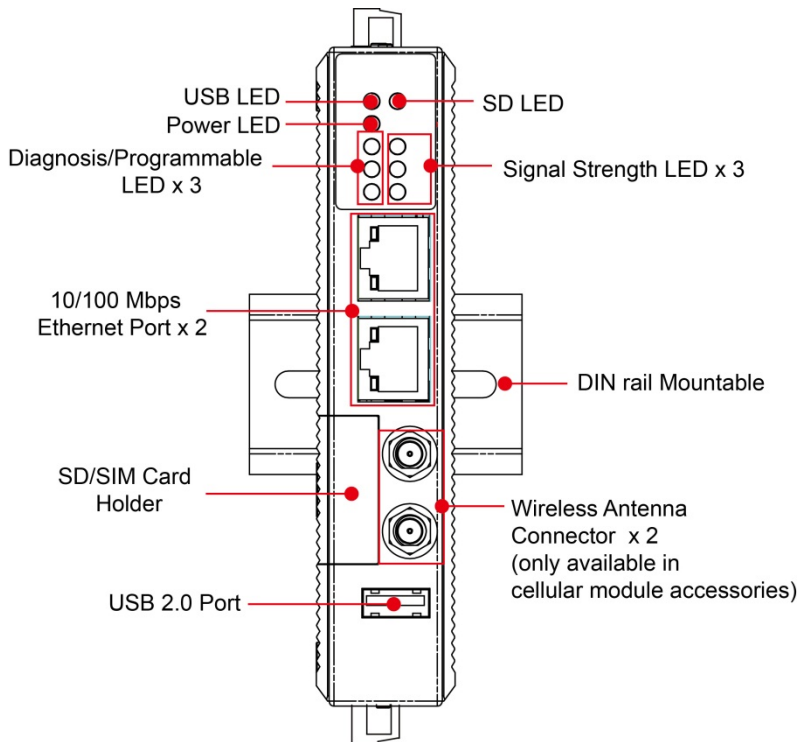

Top & Bottom Views

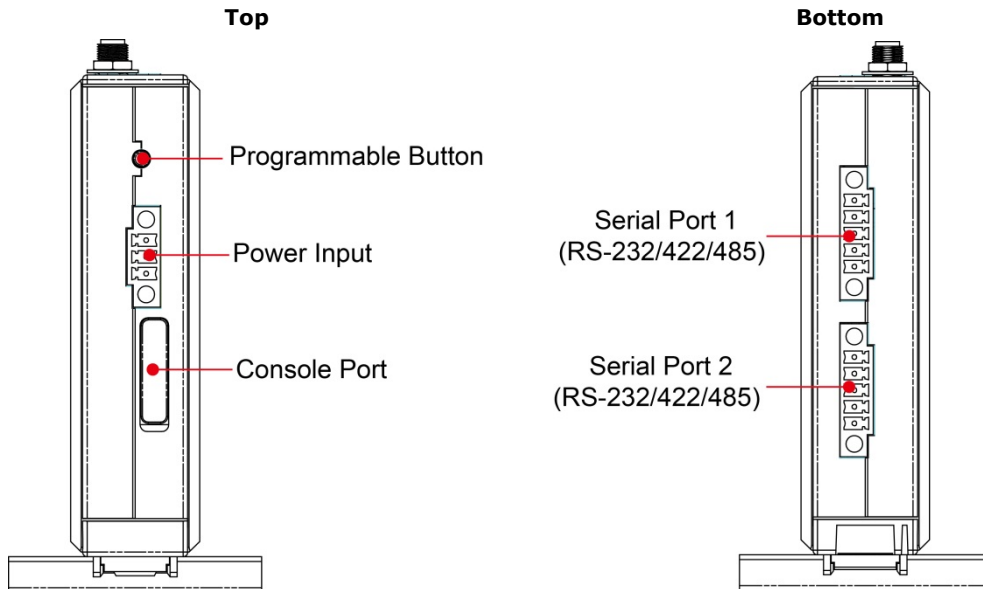



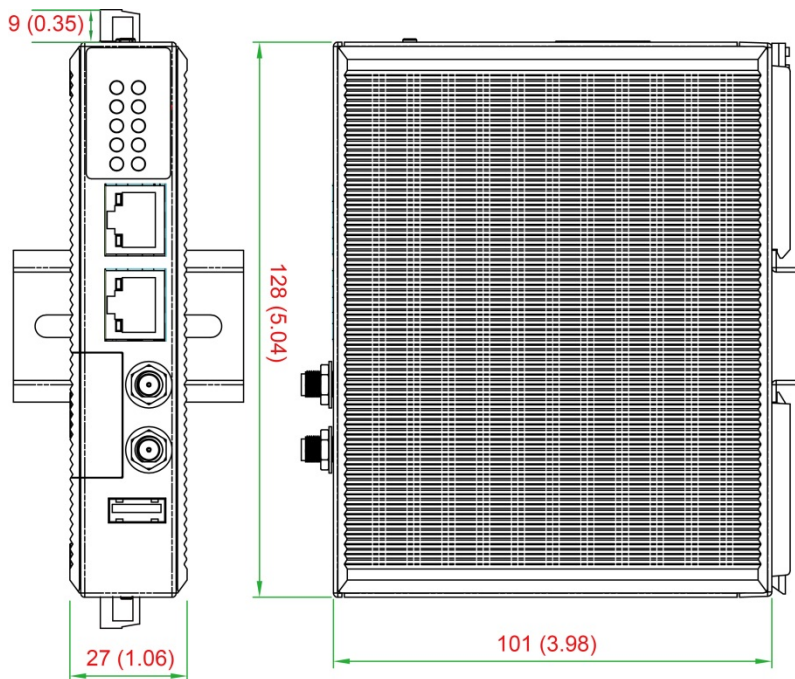



Dimensions [units: mm (in)]



LED Indicators

Refer to the following table for information about each LED.

LED Name		Color	Function	
	USB	Green	Steady On	USB device is connected and working normally
			Off	USB device is not connected.
	SD	Green	Steady On	SD Card inserted and working normally
			Off	SD Card is not detected
	Power	Green	Power is on and the computer is working normally.	
		Off	Power is off.	
	LAN1/2 (On RJ45 connector)	Green	Steady On	100 Mbps Ethernet link
			Blinking	Data transmitting
		Yellow	Steady On	10 Mbps Ethernet link
			Blinking	Data transmitting
	Wireless Signal Strength	Green Yellow Red	Number of glowing LEDs indicates signal strength	
			3 (Green + Yellow + Red): Excellent	
			2 (Yellow + Red) : Good	
		Red	1 (Red) : Poor	
	Diagnosis Programmable	Off	Wireless module is not detected	
		Green Yellow Red	Refer to the section Chapter 3 in Hardware Manual for details. These 3 LEDs are programmable; refer to Chapter 5 in Hardware Manual for details.	

Default Programmable Button Operations

The push button is used to diagnose device failure or to perform firmware restoration. After depressing the button, release it at the appropriate time to enter the desired mode to either diagnose your device or restore your device to the default configuration. See below for detailed instructions.

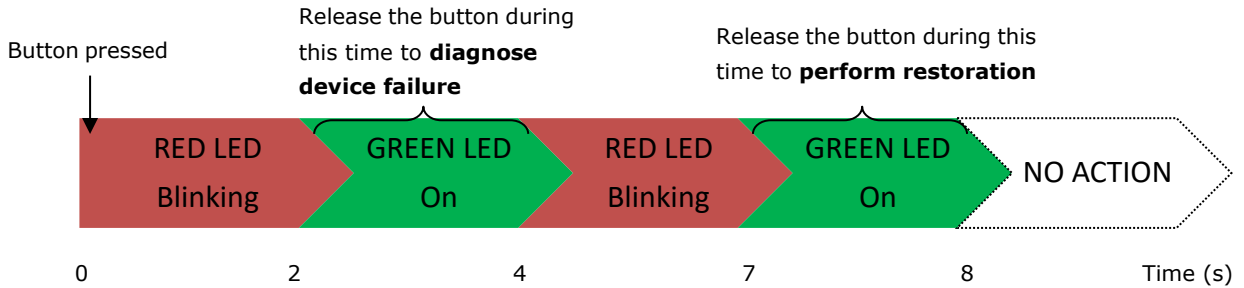

The LED indicators behave differently when diagnosing a device failure compared to performing a firmware restoration. See the following table for details.

Status	Red LED	Yellow LED	Green LED
Executing diagnostics program	Blinking	Off	On
Resetting to default configuration	Blinking	Blinking	On

Diagnosing Device and Subsystem Failures

The red LED will start blinking once you press the push button. Keep the button pressed until the green LED is lit for the first time and then release the button to enter diagnostic mode to check which peripherals are available on the UC-8100-LX. When the diagnostic program is executing, the red LED will be blinking.

Status	Red LED	Yellow LED	Green LED
Diagnostics program is executing	Blinking	Off	On

The following two tables describe the diagnostics results related to hardware defects and system operation.

Hardware Defects

If you observe any of these hardware issues, contact Moxa for further instructions.

Status	Red LED	Yellow LED	Green LED
UART1 device issue	On	On	Off
UART2 device issue (except UC-8131)	On	On	Blinking
LAN 1 device issue	On	Off	Off
LAN 2 device issue	On	Off	Blinking
Button device issue	On	Blinking	Off
TPM device issue	On	Blinking	Blinking
LED device issue	On	Off	Off

System Operation

If you observe any of the following issues, check the item indicated by the LEDs.

Status	Red LED	Yellow LED	Green LED
CPU usage (over 90%)	Blinking	On	Off
RAM usage (over 90%)	Off	On	Off
Disk usage (over 90%)	Off	On	Blinking
File system corrupted	Blinking	On	Blinking

Reset to Default Button

Press and hold the **Reset Button** continuously for at least 5 seconds to load the **factory default configuration**. After the factory default configuration has been loaded, the system will reboot automatically. The **Power LED** will blink on and off for the first 5 seconds, and then maintain a steady glow once the system has rebooted.

We recommend that you only use this function if the software is not working properly and you want to load factory default settings. The **Reset to Default** functionality is not designed to hard reboot the UC-8100.



ATTENTION

Reset to Default preserves user's data

The **Reset to Default** function will NOT format the user directory and erase the user's data. Using the Reset to default function will only load the configuration file. The rest of the user's data stored in the Flash ROM will remain intact.

Real Time Clock

The UC-8100's real time clock is powered by a non-rechargeable battery. When the computer is not plugged into a power supply, the battery has an estimated life around 1 year. When the computer is plugged into power supply, the standby current source will be switch to the power supply. We strongly recommend that you do not replace the battery without help from a qualified Moxa support engineer. If you need to change the battery, contact the Moxa RMA service team.



WARNING

There is a risk of explosion if the battery is replaced by an incorrect type.

Placement Options

There are two sliders on the back of the unit for DIN-rail and wall mounting.

DIN-rail Mounting

Pull out the bottom slider, latch the unit onto a DIN rail, and push the slider back in.

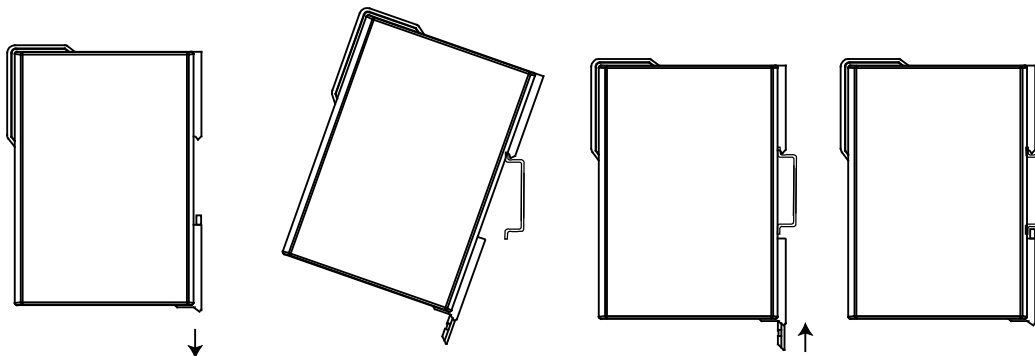

Wall or Cabinet Mounting

Pull out both the top and bottom sliders and align the screws accordingly.

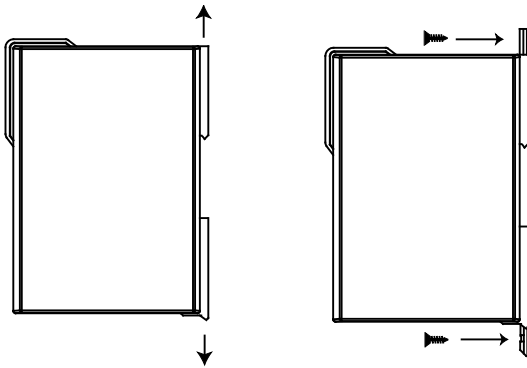

Another method for wall mounting installation is to use the optional wall mounting kit. Attach two mounting brackets on the side panel of the computer, and fasten with screws. Install the computer on a wall or cabinet by fastening two screws for each bracket.

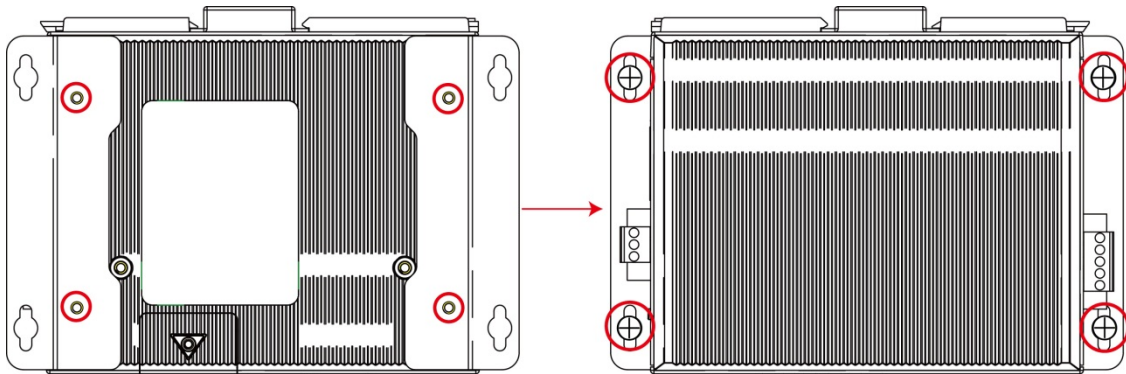

NOTE Before tightening the screws into the wall, make sure the screw head and shank size are suitable by inserting the screw into one of the keyhole-shaped apertures of the wall mounting plates.

Hardware Connection Description

This section describes how to connect the UC-8100 to a network and various devices for first time testing purposes.

The following topics are covered in this chapter:

- ❑ **Wiring Requirements**
 - Connecting the Power
 - Grounding the Unit
- ❑ **Connecting to the Console Port**
- ❑ **Connecting to the Network**
- ❑ **Connecting to a Serial Device**
- ❑ **Inserting the SD and SIM Card**
- ❑ **USB Port**
- ❑ **Installing the Cellular Module**

Wiring Requirements

In this section, we describe how to connect various devices to the embedded computer. You should heed the following common safety precautions before proceeding with the installation of any electronic device:

- Use separate paths to route wiring for power and devices. If power wiring and device wiring paths must cross, make sure the wires are perpendicular at the intersection point.
NOTE: Do not run signal or communication wiring and power wiring in the same wire conduit. To avoid interference, wires with different signal characteristics should be routed separately.
- You can use the type of signal transmitted through a wire to determine which wires should be kept separate. The rule of thumb is that wiring that shares similar electrical characteristics can be bundled together.
- Keep input wiring and output wiring separate.
- When necessary, it is strongly advised that you label wiring to all devices in the system.



ATTENTION

Safety First!

Be sure to disconnect the power cord before doing installations and/or wiring.

Electrical Current Caution!

Calculate the maximum possible current in each power wire and common wire. Observe all electrical codes dictating the maximum current allowable for each wire size.

If the current goes above the maximum ratings, the wiring could overheat, causing serious damage to your equipment.

Temperature Caution!

Be careful when handling the unit. When the unit is plugged in, the internal components generate heat, and consequently the outer casing may feel hot to the touch.

Connecting the Power

Terminal Block

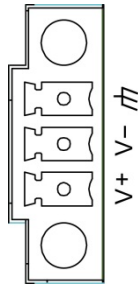

The UC-8100 has a 3-pin terminal block for a 12 to 24 VDC power input.

The figure shows how the power input interface connects to external power sources. If the power is properly supplied, the Power LED will light up. The Power LED will glow a solid green color when the operating system is ready (it may take 30 to 60 seconds for the operating system to boot up).



ATTENTION

The power for this product is intended to be supplied by a Listed Power Supply Unit that is rated to deliver 12 to 24 VDC at a minimum of 450 mA @ 12 VDC, and 225 mA @ 24 VDC.

Grounding the Unit

Grounding and wire routing help limit the effects of noise due to electromagnetic interference (EMI). Run the ground connection from the ground screw to the grounding surface prior to connecting devices.



ATTENTION

This product is intended to be mounted to a well-grounded mounting surface, such as a metal panel.

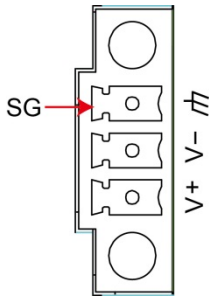

SG: The Shielded Ground (sometimes called Protected Ground) contact is the bottom contact of the 3-pin power terminal block connector when viewed from the angle shown here. Connect the SG wire to an appropriate grounded metal surface.



ATTENTION

A shielded power cord is required to meet FCC emission limits and also to prevent interference with nearby radio and television reception. It is essential that only the supplied power cord be used. You are cautioned that changes or modifications not expressly approved by the party responsible for compliance could void your authority to operate the equipment.

Connecting to the Console Port

The UC-8100's console port is a 4-pin pin-header RS-232 port located on the top panel of the case. It is designed for serial console terminals, which are useful for identifying the boot up message, or for debugging when the system cannot boot up.

Serial Console Port & Pinouts		Serial Console Cable										
	<table border="1"> <thead> <tr> <th>Pin</th> <th>Signal</th> </tr> </thead> <tbody> <tr> <td>1</td> <td>TxD</td> </tr> <tr> <td>2</td> <td>RxD</td> </tr> <tr> <td>3</td> <td>NC</td> </tr> <tr> <td>4</td> <td>GND</td> </tr> </tbody> </table>	Pin	Signal	1	TxD	2	RxD	3	NC	4	GND	
Pin	Signal											
1	TxD											
2	RxD											
3	NC											
4	GND											

Connecting to the Network

Connect one end of the Ethernet cable to one of the UC-8100's 10/100M Ethernet ports (8-pin RJ45) and the other end of the cable to the Ethernet network. If the cable is properly connected, the UC-8100 will indicate a valid connection to the Ethernet in the following ways:

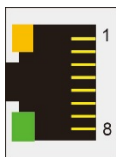

The LED indicator in the lower right corner glows a solid green color when the cable is properly connected to a 100 Mbps Ethernet network. The LED will flash on and off when Ethernet packets are being transmitted or received.

The LED indicator in the upper right corner glows a solid orange color when the cable is properly connected to a 10 Mbps Ethernet network. The LED will flash on and off when Ethernet packets are being transmitted or received.

Pin	Signal
1	ETx+
2	ETx-
3	ERx+
4	-
5	-
6	ERx-
7	-
8	-

Connecting to a Serial Device

Use properly wired serial cables to connect the UC-8100 to serial devices. The serial ports of the UC-8100 use the 5-pin terminal block. The ports can be configured by software for RS-232, RS-422, or 2-wire RS-485. The precise pin assignments are shown in the following table:

Terminal Block

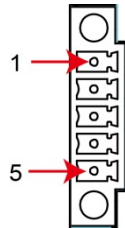

RS-232/422/485 Pinouts

Pin	RS-232	RS-422	RS-485
1	TXD	TXD+	-
2	RXD	TXD-	-
3	RTS	RXD+	D+
4	CTS	RXD-	D-
5	GND	GND	GND

Inserting the SD and SIM Card

The UC-8100 comes with an SD socket for storage expansion, and a SIM card socket that can be installed with a SIM card for cellular communication. The SD card/SIM card sockets are located on the lower part of the front panel. To install them, remove the screw and the protection cover to access the socket, and then plug the SD card and the SIM card into the sockets directly. Remember to push in on the SD card or SIM card first if you want to remove them.

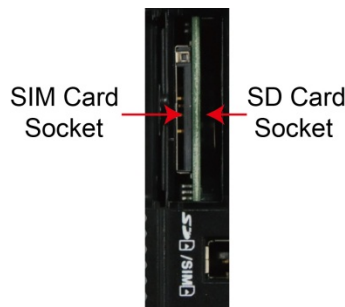
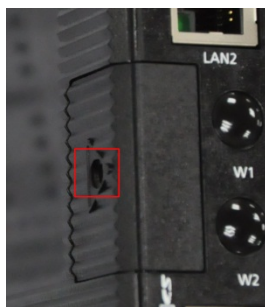

ATTENTION

The UC-8100 does not support SD hot swap and PnP (Plug and Play) functionality. It is necessary to remove power source first before inserting or removing the SD card.

USB Port

The UC-8100 provides 1 USB 2.0 full speed port (OHCI), type A connector, which supports a keyboard or mouse, as well as an external flash disk for storing large amounts of data.

Installing the Cellular Module

The UC-8100 provides a Mini PCIe socket for installing a cellular module. The cellular module package includes the following items.

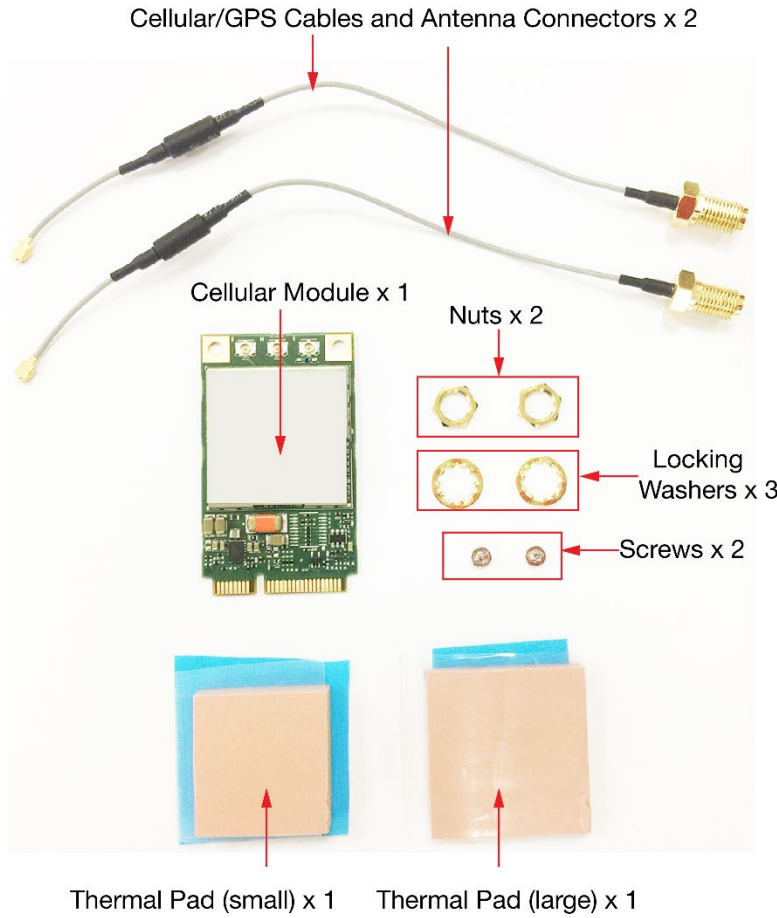

Follow these steps to install the cellular module.

1. Unfasten the screws on the side panel of the computer and remove the cover.

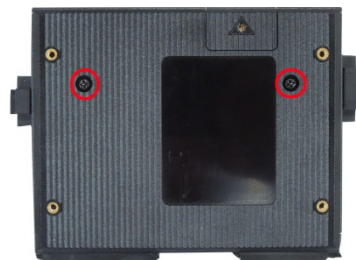

2. Find the location of the PCIe socket.

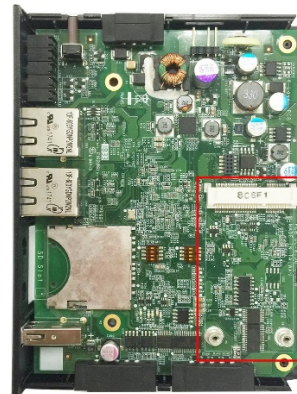

- Remove the plastic plate and the sticker on both sides of the **large** thermal pad and place it in the socket. Press the thermal pad down so that it sticks to the base of the socket.
Place the thermal pad as close as possible to the holes for the screws used to secure the module.

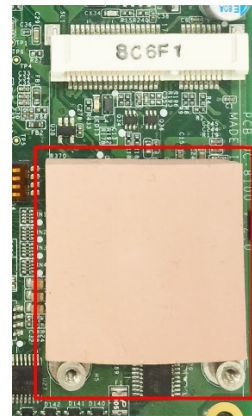

- Insert the cellular module into the socket and tighten the screws to secure the module to the socket.

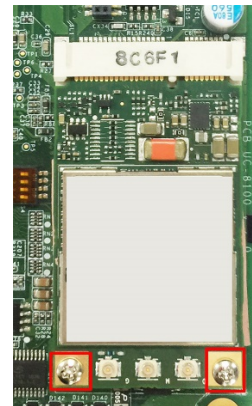

- Remove the plastic plate and the sticker on both side of the **small** thermal pad and stick the thermal pad on to the module.

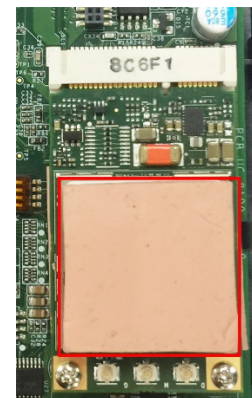

- Install the antenna cables.
There are three antenna connectors on the module; two for cellular antennas and one for a GPS antenna. Refer to the figure for details. As there are only two antenna connector holes on the front panel of the computer, you can only use two antennas at a time. You may use two cellular antennas, or a cellular antenna and a GPS antenna. The same antenna cables can be used for both antenna types.

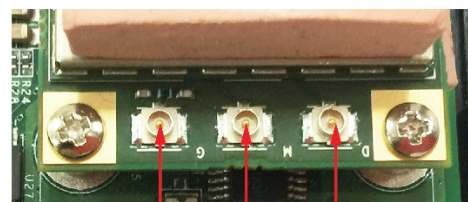

GPS Antenna Connector Cellular Antenna Connectors 2
Cellular Antenna Connectors 1

- 7. Connect one end of the antenna cable to the cellular module.

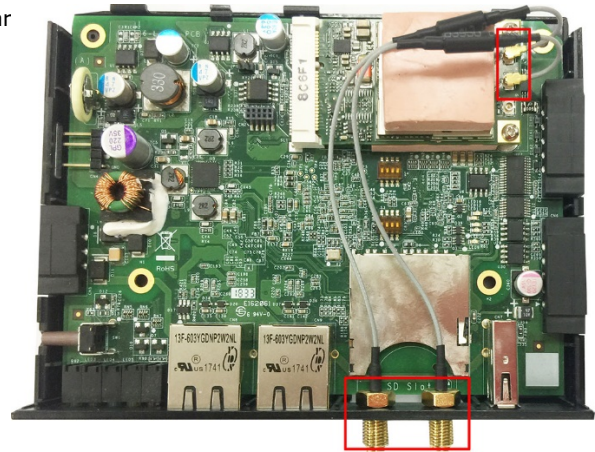

- 8. Insert the other end of the cable, with the connector, through the antenna connector hole on the front panel of the computer. Remove the black plastic protection cover on the connector hole before you insert the antenna wire.

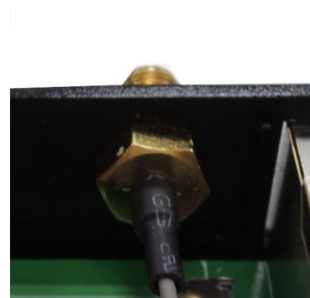

- 9. Insert the locking washer through the connector and press it against the cover of the computer. Then, insert the nut and tighten it to secure the connector to the cover.

Locking Washer

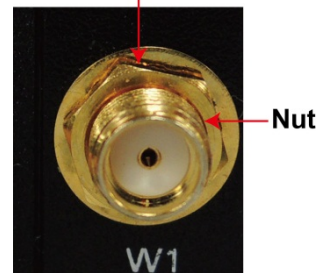

- 10. Connect the antenna to the antenna connector.
- 11. Replace the cover of the computer.



A

Regulatory Approval Statements



This device complies with part 15 of the FCC Rules. Operation is subject to the following two conditions: (1) This device may not cause harmful interference, and (2) this device must accept any interference received, including interference that may cause undesired operation.

Class A: FCC Warning! This equipment has been tested and found to comply with the limits for a Class A digital device, pursuant to part 15 of the FCC Rules. These limits are designed to provide reasonable protection against harmful interference when the equipment is operated in a commercial environment. This equipment generates, uses, and can radiate radio frequency energy and, if not installed and used in accordance with the instruction manual, may cause harmful interference to radio communications. Operation of this equipment in a residential area is likely to cause harmful interference in which case the users will be required to correct the interference at their own expense.



European Community



WARNING

This is a class A product. In a domestic environment this product may cause radio interference in which case the user may be required to take adequate measures.