

ioMirror E3210 User's Manual

Edition 3.3, June 2017

www.moxa.com/product



© 2017 Moxa Inc. All rights reserved.

ioMirror E3210 User's Manual

The software described in this manual is furnished under a license agreement and may be used only in accordance with the terms of that agreement.

Copyright Notice

© 2017 Moxa Inc. All rights reserved.

Trademarks

The MOXA logo is a registered trademark of Moxa Inc.
All other trademarks or registered marks in this manual belong to their respective manufacturers.

Disclaimer

Information in this document is subject to change without notice and does not represent a commitment on the part of Moxa.

Moxa provides this document as is, without warranty of any kind, either expressed or implied, including, but not limited to, its particular purpose. Moxa reserves the right to make improvements and/or changes to this manual, or to the products and/or the programs described in this manual, at any time.

Information provided in this manual is intended to be accurate and reliable. However, Moxa assumes no responsibility for its use, or for any infringements on the rights of third parties that may result from its use.

This product might include unintentional technical or typographical errors. Changes are periodically made to the information herein to correct such errors, and these changes are incorporated into new editions of the publication.

Technical Support Contact Information

www.moxa.com/support

Moxa Americas

Toll-free: 1-888-669-2872
Tel: +1-714-528-6777
Fax: +1-714-528-6778

Moxa Europe

Tel: +49-89-3 70 03 99-0
Fax: +49-89-3 70 03 99-99

Moxa India

Tel: +91-80-4172-9088
Fax: +91-80-4132-1045

Moxa China (Shanghai office)

Toll-free: 800-820-5036
Tel: +86-21-5258-9955
Fax: +86-21-5258-5505

Moxa Asia-Pacific

Tel: +886-2-8919-1230
Fax: +886-2-8919-1231

Table of Contents

1. Introduction	1-1
Welcome	1-2
Features	1-3
Infrastructure Examples	1-4
Ethernet Network	1-4
Fiber Optic Network	1-4
Wireless LAN	1-4
Package Checklist	1-5
Specifications	1-5
LAN	1-5
Digital Input	1-5
Digital Output	1-5
Alarm Port	1-5
Software	1-6
Power	1-6
Environmental	1-6
Certifications	1-6
Accessories	1-6
Physical Dimensions (Units = mm)	1-6
Hardware Overview	1-8
Pin Assignments	1-8
LED Indicators	1-9
2. Hardware Installation	2-1
Connecting the Hardware	2-2
Connecting the Power	2-2
Grounding the Unit	2-2
Connecting to the Network	2-2
Connecting the I/O Device	2-2
Setting the IP Address	2-3
Static or Dynamic IP	2-3
Factory Default Settings	2-3
Modifying IP Address	2-4
3. Using the Web Console	3-1
Overview	3-2
Opening the Web Console	3-2
Navigation	3-2
Quick Reference	3-3
Basic Settings	3-3
Network Settings	3-4
General Settings	3-4
Ethernet Configurations	3-4
I/O Settings	3-5
DI Channels Settings	3-5
DO Channel Settings	3-5
ioMirror Settings	3-6
System Management	3-7
Accessible IP Settings	3-7
Network Connection	3-8
LCM	3-8
Change Password	3-9
Load Factory Default	3-9
Save/Restart	3-9
4. ioMirrorAdmin and ioEventLog	4-1
Overview	4-2
Installation	4-2
ioMirrorAdmin	4-3
Searching for ioMirror Servers	4-3
Wiring Guide	4-4
ioMirror Configuration	4-4
Firmware Update	4-5
Restart System	4-5
Reset to Default	4-5
ioEventLog	4-6
Basic Functions	4-6
Configuration	4-7
Opening Log Files	4-7
Clearing the Log	4-8

A. LCD Display Kit	A-1
Controls	A-1
Menu Options.....	A-1
B. Modbus/TCP Address Mappings	B-1
ioMirror E3210 Modbus Mapping	B-1
0xxxx Read/Write Coils (Functions 1, 5, 15)	B-1
1xxxx Read Only Coils (Function 2)	B-1
3xxxx Read Only Registers (Function 4)	B-2
4xxxx Read/Write Registers (Functions 3, 6, 16)	B-2
Function 8	B-2
C. Used Network Port Numbers	C-1
ioMirror E3210 Network Port Usage.....	C-1
D. Factory Default Settings	D-1
E. Pinouts and Cable Wiring	E-1
Port Pinout Diagrams	E-2
Ethernet Port Pinouts	E-2
Digital I/O Structure	E-2
Digital Input Structure	E-2
Digital Output Structure	E-3
Alarm Output Structure.....	E-3

Introduction

The ioMirror E3210 is a peer-to-peer Ethernet I/O server that acts as a cable replacement solution for connecting digital input sensors to PLC controller or DCS systems. Typical applications involve using a pair of ioMirror servers, one on each end of the connection.

The following topics are covered in this chapter:

- **Welcome**
- **Features**
- **Infrastructure Examples**
 - Ethernet Network
 - Fiber Optic Network
 - Wireless LAN
- **Package Checklist**
- **Specifications**
 - LAN
 - Digital Input
 - Digital Output
 - Alarm Port
 - Software
 - Power
 - Environmental
 - Certifications
 - Accessories
- **Physical Dimensions (Units = mm)**
- **Hardware Overview**
 - Pin Assignments
 - LED Indicators

Welcome



The ioMirror E3210 is a cable-replacement solution that connects digital input signals to digital outputs over an IP network. It is equipped with 8 digital inputs, 8 digital outputs, and a 10/100Mbps Ethernet interface. A pair of ioMirror servers can connect remote sensor signals to a PLC controller, DCS systems, or a display device over Ethernet, eliminating the need to install additional signal wires. Up to 8 digital input signals can be connected from one ioMirror to another with only 20 ms signal latency over a local area network.

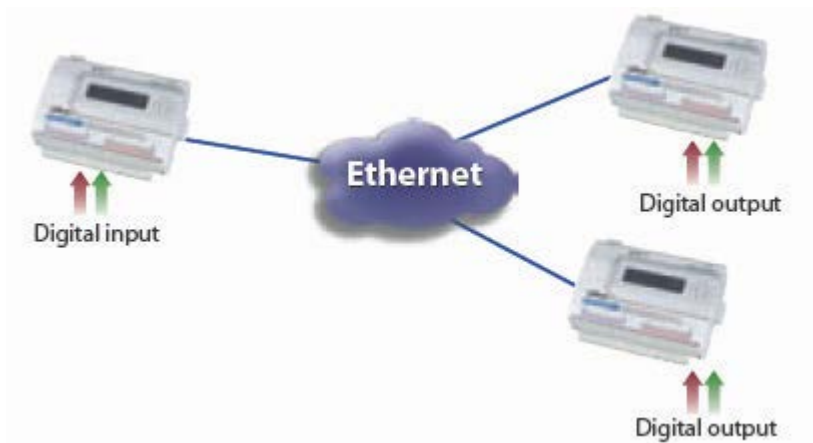

Industrial Business Automation Applications

The ioMirror is a fast and easy way to connect input and output signals over IP networks. It is ideal for non-mission critical applications such as remote monitoring. Maximum transmission distance can be achieved without programming and without a separate controller. Potential applications include the following:

- Remote signal display
- Signal splitting
- System monitoring
- Tank level, pump, and valve control/monitoring
- Power station signal monitoring
- Telecom machine room monitoring
- Security signal display for factory, office or public building

Features

- **High speed mirroring of digital I/O signals over Ethernet**

The ioMirror E3210 transmits digital I/O signals over Ethernet at very high speeds, with less than 20 ms latency in a local area 100Mbps network. The extremely low latency makes ioMirror E3210 an excellent choice for transmitting low and middle-speed signals, such as liquid level or optical sensor input.
- **Easiest setup for digital output signals driven by remote input**

The ioMirrorAdmin utility for Windows makes it easy to configure input-to-output mapping, both locally and remotely. Basic Configuration is provided for module -to-module mapping. Advanced Configuration is provided for more flexible channel-to-channel mapping, and allows one digital input signal to be mapped to multiple digital outputs. Remote configuration can also be completed using a web browser interface.
- **Designed to use existing Ethernet infrastructure, saving time and wiring cost**

With a high speed Ethernet infrastructure already in place, there is no longer any reason to go through the expense and effort of laying down additional I/O wiring. Modern Ethernet, fiber optic lines, or WLAN can provide high speed connectivity, with general input/output signals carried by a pair of ioMirror I/O servers. Wiring plans are now easier than ever.
- **No programming, and no separate PLC or PC controller**

A separate PLC or PC controller is not required for ioMirror operation. No ladder or C programming is required, either. All configuration can be done through ioMirrorAdmin or through the web console.
- **Local sensor signals duplicated to up to sixteen locations**

Each digital input signal can be mapped to two IP destinations. For example, you may monitor the eight tank level signals by up to sixteen display panels at the same time.
- **Easy and flexible installation**

The Windows utility for installation and configuration is easy to use. For basic module-to-module configuration, you may simply assign the destination IP address for mapping. For advanced configuration, you can easily specify the mapping destination for each channel.
- **Easy troubleshooting tools**

ioMirror connections are easily monitored and managed. There are many tools and features that can alert you to a problem or show you the status of a connection:

 - Optional LCD display for local IP configuration
 - Instant error status with special built-in alarm port for 24 VDC alarm devices, such as buzzer or LED tower
 - Alarm and event log that records each connection and disconnection
 - Windows utility that displays channel mappings and status for every ioMirror server on the network
 - Automatic recovery within seconds when network is reconnected, without rebooting
 - Modbus/TCP support for SCADA systems

Infrastructure Examples

Ethernet Network

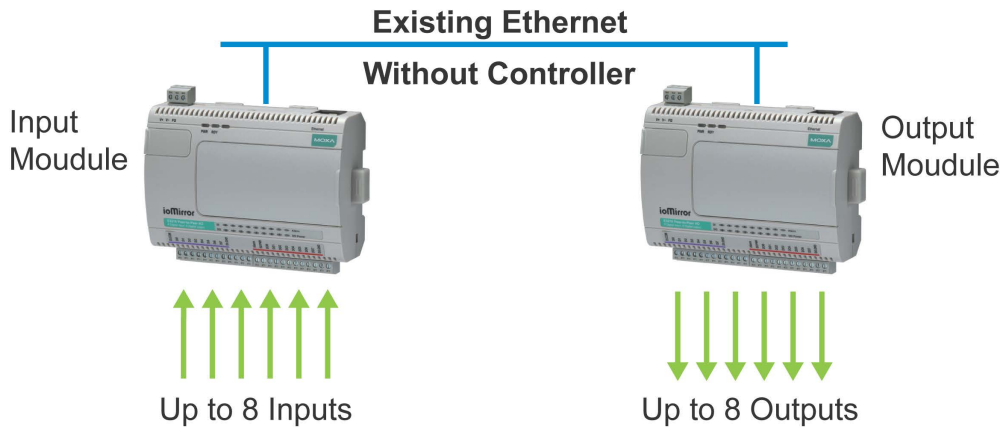

Fiber Optic Network

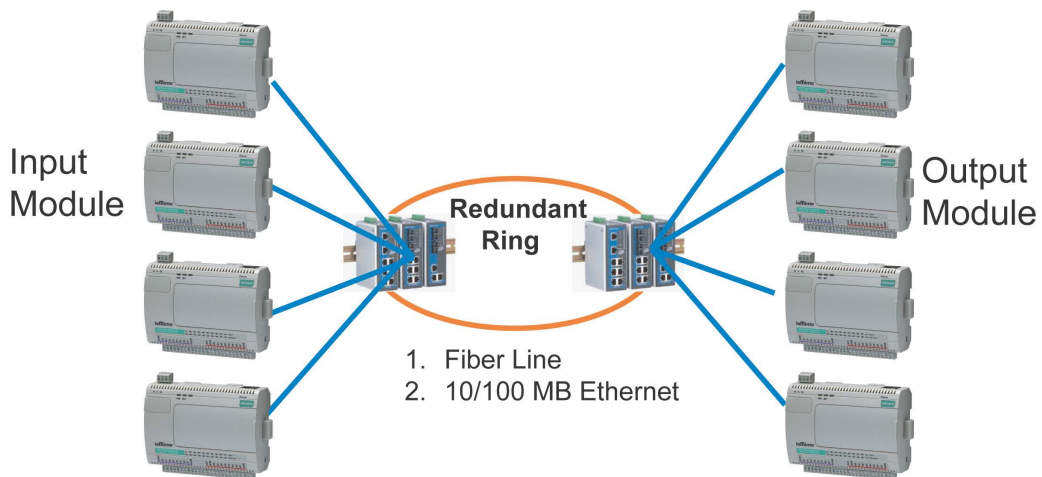

Wireless LAN

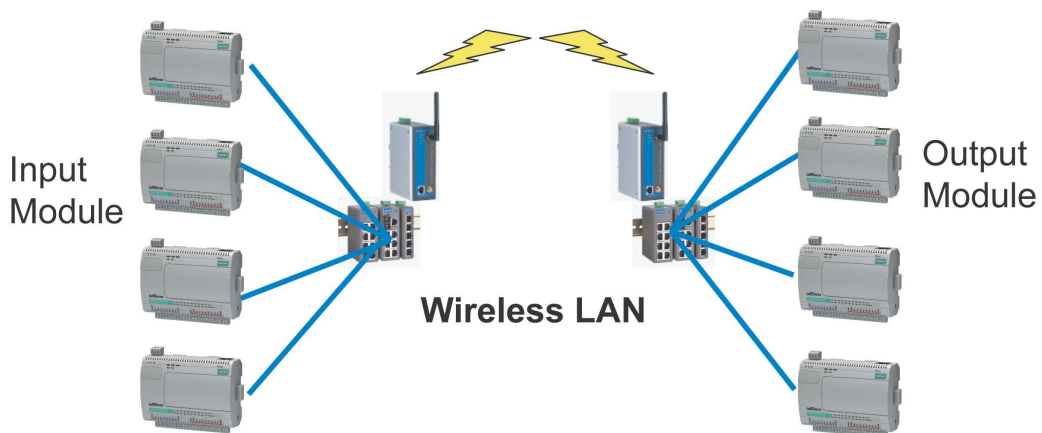

Package Checklist

Standard Accessories

- ioMirror E3210 peer-to-peer Ethernet I/O server

Optional Accessories

- LDP1602 ioMirror LCD display kit

NOTE: Notify your sales representative if any of the above items are missing, or damaged.

Specifications

LAN

Interface	10/100BaseTx with MDI/MDIX, RJ45
Protocols	DHCP, BootP, TCP, UDP, IP, ICMP, ARP, HTTP, SNMP, ioMirror Modbus/TCP up to 3 sockets
Protection	1.5 KV magnetic isolation
IP Address	Fixed, dynamic (DHCP) Default 192.168.127.254

Digital Input

Channels	8 points, source type, dry contact or wet contact
I/O Mode	Digital Input
Dry Contact	Logic 0: close to GND Logic 1: open
Wet Contact	Logic 0: 0 to 3 VDC Logic 1: 10 to 30 VDC (DI COM to DI)
Isolation	3K VDC/2 KVRms
Common Type	8 points/1 COM

Digital Output

Channels	8 points, sink type
I/O Mode	Digital Output
On-state Voltage	24 VDC nominal
Output Current Rating	Max 200 mA per channel
Optical Isolation	2K VDC/2 KVRms
Common Type	8 points/1 COM
Protection	Over voltage protection: +50 VDC Over current limit: 600 mA (typical) Over temperature shutdown: 160°C min

Alarm Port

Channels	1 point, sink type
On-state Voltage	24 VDC nominal
Output Current Rating	Max 200 mA
Optical Isolation	3K VDC/2 KVRms

Software

Utilities	ioMirrorAdmin for Windows
Configuration	Web browser, ioMirrorAdmin

Power

Power Input	24 VDC nominal, 12 (min) to 48 VDC (max)
Power Consumption	3.26 W @ 24 VDC (typical)
DO Power	24 VDC nominal, up to 48 VDC
Wiring	I/O cable max 14 AWG

Environmental

Operating Temperature	-10 to 60°C
Storage Temperature	-40 to 85°C
Altitude	Up to 2000 m

Note: Please contact Moxa if you require products guaranteed to function properly at higher altitudes.

Certifications

Shock, Free fall, Vibration
 CE Class A, Level 3, Criteria B
 FCC Part 15, CISPR (EN55022) Class A UL508
 EC61000-6-2, EC61000-6-4

Accessories

LCD Display Kit	Hot-pluggable attachment for IP display, DI/DO status 16 × 2 character display Backlit screen 5 buttons
------------------------	--

Physical Dimensions (Units = mm)

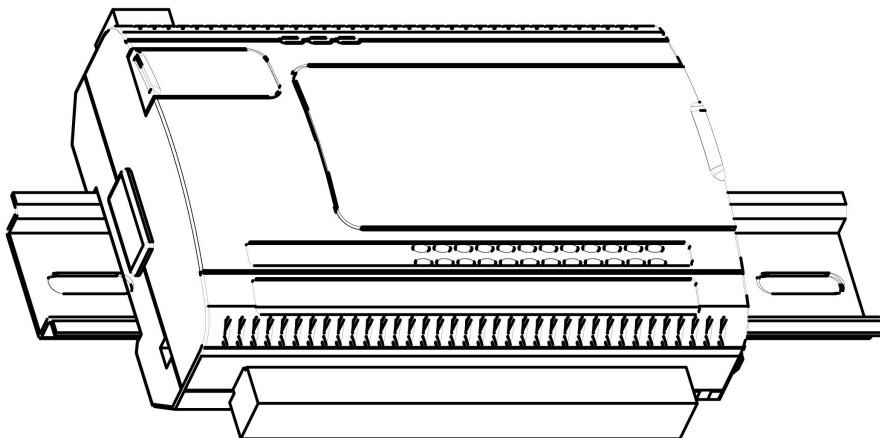

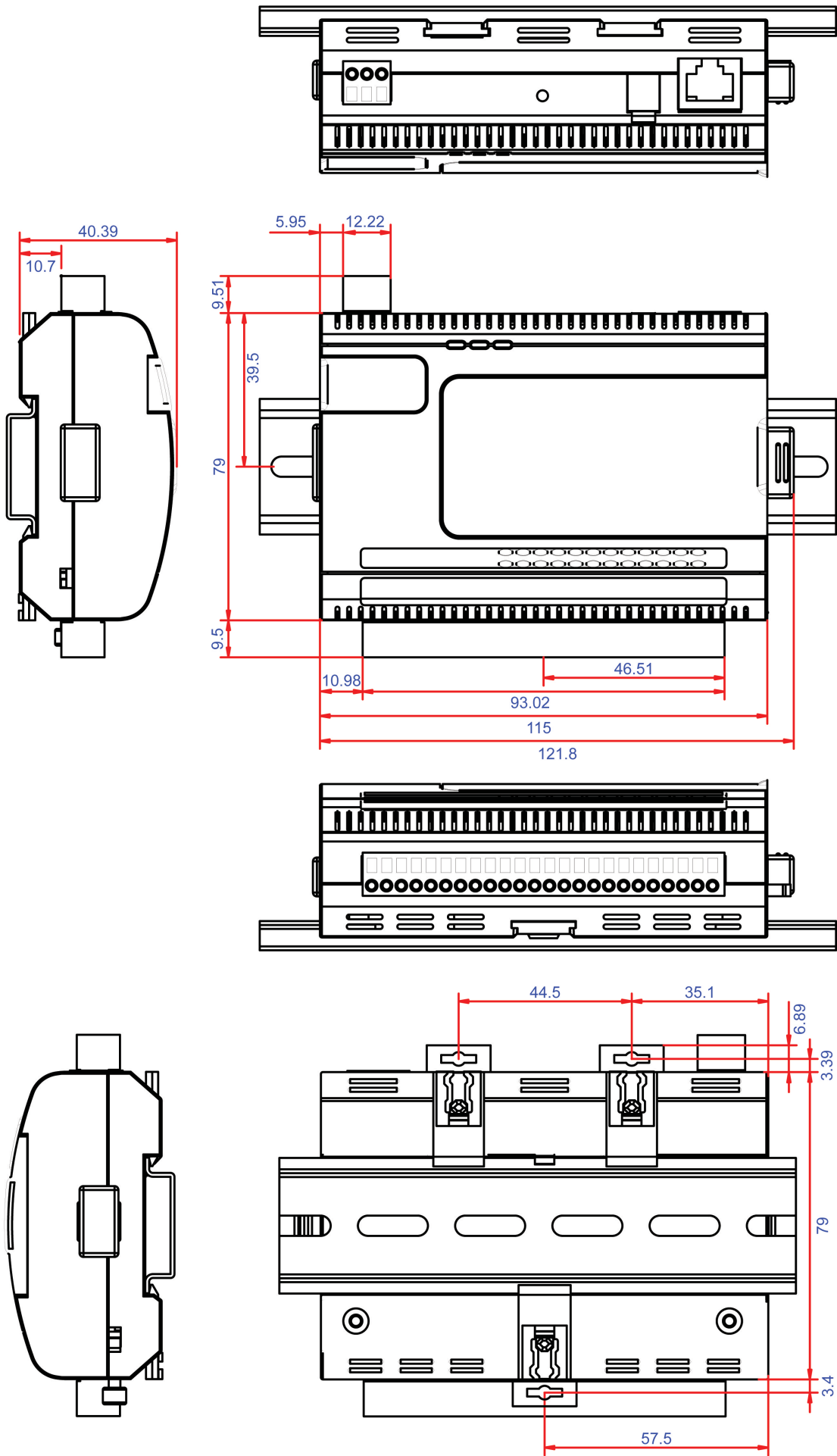

Hardware Overview

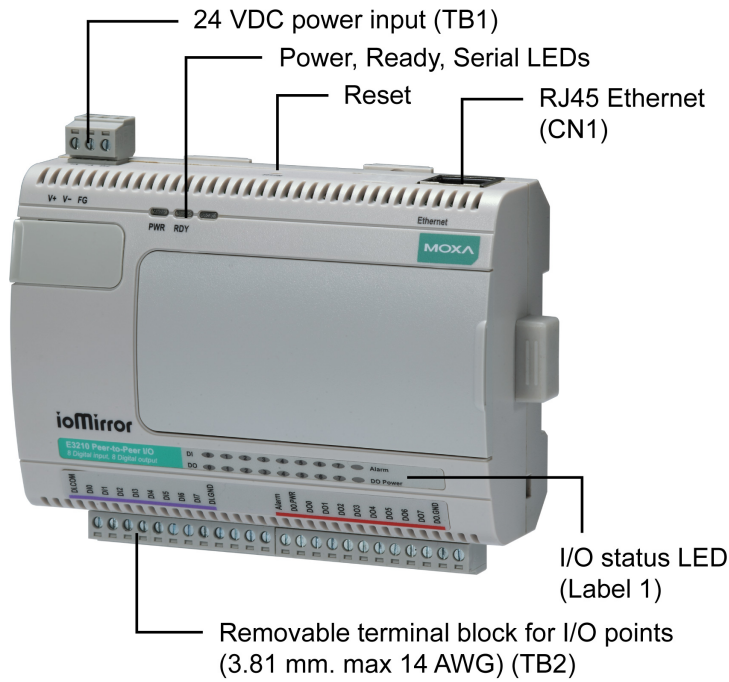

Please note that the LCD display module is an optional accessory.

Reset Button – The reset button is used to load factory defaults. Use a pointed object, such as a straightened paper clip or toothpick, to hold the reset button down for 5 seconds. The Ready LED will turn red as the factory defaults are loaded and will change to green when the operation is complete.

Pin Assignments

Ethernet (CN1)

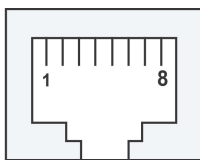

Pin	Signal
1	Tx+
2	Tx-
3	RX+
6	Rx-

Power (TB1)

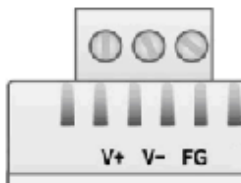

I/O (TB2)

(Left to right)

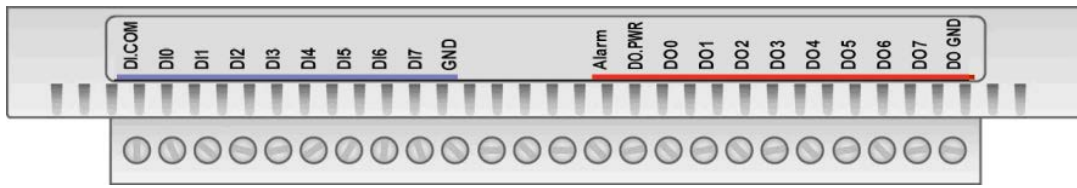

Pin	1	2	3	4	5	6	7	8	9	10	11	12
Signal	DI COMM	DI0	DI1	DI2	DI3	DI4	DI5	DI6	DI7	DI GND	-	-

Pin	13	14	15	16	17	18	19	20	21	22	23	24
Signal	-	Alarm	DO PWR	DO0	DO1	DO2	DO3	DO4	DO5	DO6	DO7	DO GND

LED Indicators

Ethernet LEDs		
Ethernet	Orange	Live 10Mbps Ethernet connection
	Green	Live 100Mbps Ethernet connection
	Flashing	Transmitting or receiving data
System LEDs		
PWR	Red	Power is on
	Off	Power is off
Ready	Red	System error
	Green	ioMirror is functioning normally
	Off	Power error condition exists
I/O LEDs		
DI (1 to 8)	Green	Status is "on"
DO (1 to 8)	Off	Status is "off"
Alarm	Red	DI has lost connection with remote output module
	Flashing	DO has lost connection with remote input module
DO PWR	Red	DO power in

Hardware Installation

This chapter explains how to install the ioMirror E3210 peer-to-peer Ethernet I/O server.

The following topics are covered in this chapter:

▣ **Connecting the Hardware**

- Connecting the Power
- Grounding the Unit
- Connecting to the Network
- Connecting the I/O Device

▣ **Setting the IP Address**

- Static or Dynamic IP
- Factory Default Settings
- Modifying IP Address

Connecting the Hardware

Connecting the Power

Connect your 12 to 30 VDC power supply to the ioMirror's terminal block. If power is properly supplied, the "Power" LED will light up red until the system is ready.

Grounding the Unit

Connect your grounding line to the wall-mount sockets or DIN-rail.

Connecting to the Network

For initial installation, connect the ioMirror to the same LAN as your host computer, through an Ethernet switch or hub. Alternatively, you can use a straight-through Ethernet cable to connect the ioMirror directly to the host computer.

Connecting the I/O Device

DI Dry Contact

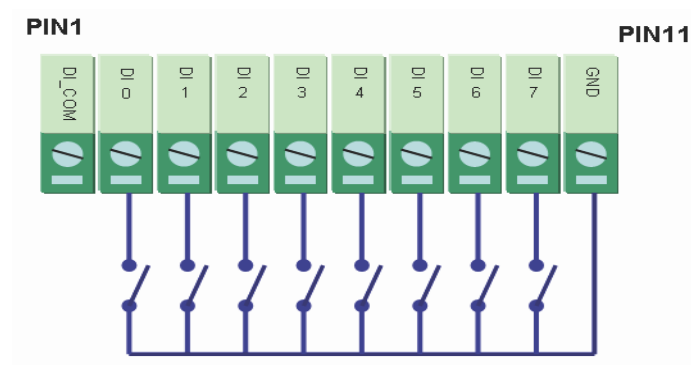

DI Wet Contact

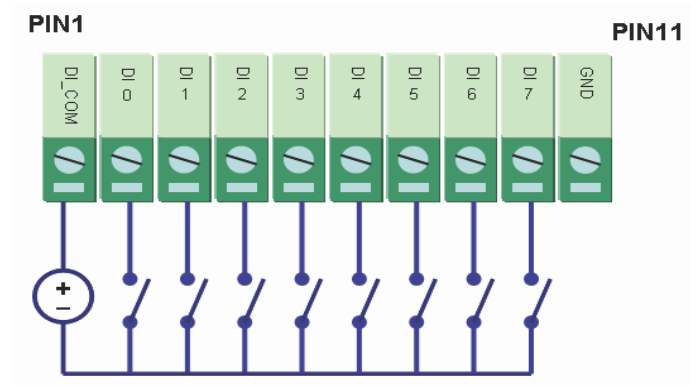

DO

Pin 15

Pin 24

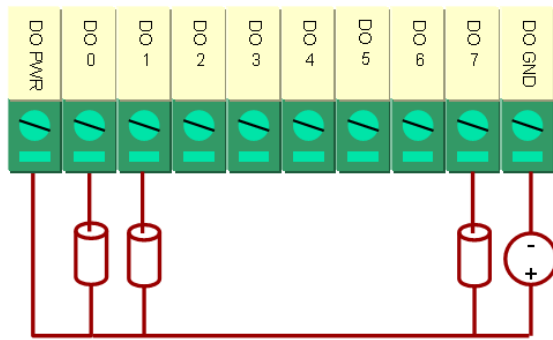
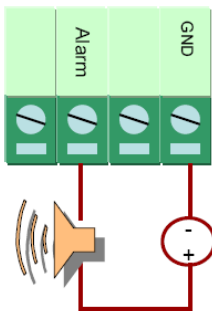
Alarm Output

Setting the IP Address

Static or Dynamic IP

The ioMirror E3210 supports both static and dynamic IP addresses. You may need to consult with your network administrator to determine how IP addresses are assigned in your network environment:

- **For a static IP environment**, you can enter a specific IP address using ioMirrorAdmin or the web console.
- **In a dynamic IP environment** (BOOTP or DHCP), you can use ioMirrorAdmin or the web console to specify the DHCP, DHCP/BOOTP, or BOOTP server that will assign the ioMirror's IP address.

Factory Default Settings

The factory default network settings are as follows:

- **IP address:** 192.168.127.254
- **Netmask:** 255.255.255.0
- **Gateway:** None

Modifying IP Address

There are several ways to modify the ioMirror's IP address. **ioMirrorAdmin** is a Windows utility that can be used locally or on the network to configure the unit and upgrade the firmware. Please refer to Chapter 4 for instructions on using ioMirrorAdmin.

The **web console** is a configuration tool that is opened using a standard web browser, through a local or network connection. Please refer to Chapter 3 for instructions on opening and using the web console.

The **LCD display kit** is an optional accessory that can be used on-site for basic monitoring and configuration. Please refer to Appendix A for instructions on using the LCD display kit

Using the Web Console

The ioMirror can be configured using a standard web browser over a direct or network connection. This chapter explains how to open and use the web console.

The following topics are covered in this chapter:

□ Overview

- Opening the Web Console
- Navigation
- Quick Reference

□ Basic Settings

□ Network Settings

- General Settings
- Ethernet Configurations

□ I/O Settings

- DI Channels Settings
- DO Channel Settings

□ ioMirror Settings

□ System Management

- Accessible IP Settings
- Network Connection

□ LCM

□ Change Password

□ Load Factory Default

□ Save/Restart

Overview

Opening the Web Console

Use a standard web browser, such as Microsoft Internet Explorer, to open the web console. Simply point the browser to your ioMirror's IP address. For initial configuration, use the ioMirror default IP address of 192.168.127.254.

The web console should appear as below:



The main page of the web console displays detailed information about your ioMirror unit, including module name, serial number, firmware version, IP address, and MAC address.

Navigation

In the web console, the left panel is the navigation panel and contains an expandable menu tree for navigating among the various settings and categories. Click on an item in the navigation panel to jump to that page. For example, if you click on **Basic Settings** in the navigation panel, the main window will show a page of basic settings that you can configure.

You can enter configuration changes directly on the page. Click on the **Submit** button at the bottom of the page after making configuration changes. The **Submit** button will be located at the bottom of every page that has configurable settings. If you navigate to another page without clicking the **Submit** button, your changes will not be retained.

Submitted changes will not take effect until they are saved and the unit is restarted! You may save and restart the server in one step by clicking on the **Save/Restart** button after you submit a change. If you need to make several changes before restarting, you may save your changes without restarting by selecting Save/Restart in the navigation panel. If you restart the unit without saving your configuration, you will lose all configuration changes that have been submitted.

Quick Reference

The following is a quick reference guide to the pages in the ioMirror’s web console. Details for each page are presented later in this chapter.

Overview	→ Show model name, serial number, etc.
Basic Settings	→ Set time, time server
Network Settings	
General Settings	→ Set name, location, DNS
Ethernet Configurations	→ Set IP address, netmask, gateway
I/O Settings	
DI Channels	→ Configure digital input channels
DO Channels	→ Configure digital output channels
ioMirror Settings	→ Configure channel/module mapping, alarm system
System Management	
Accessible IP Settings	→ Filter access by IP address
Network Connection	→ Show TCP connections from different hosts
LCM	→ Show LCM status
Change Password	→ Set password
Load Factory Default	→ Restore factory default settings
Save/Restart	→ Save all changes and reboot

Basic Settings

On the Basic Settings page, you may set the system time or provide the IP address of a time server for time synchronization.

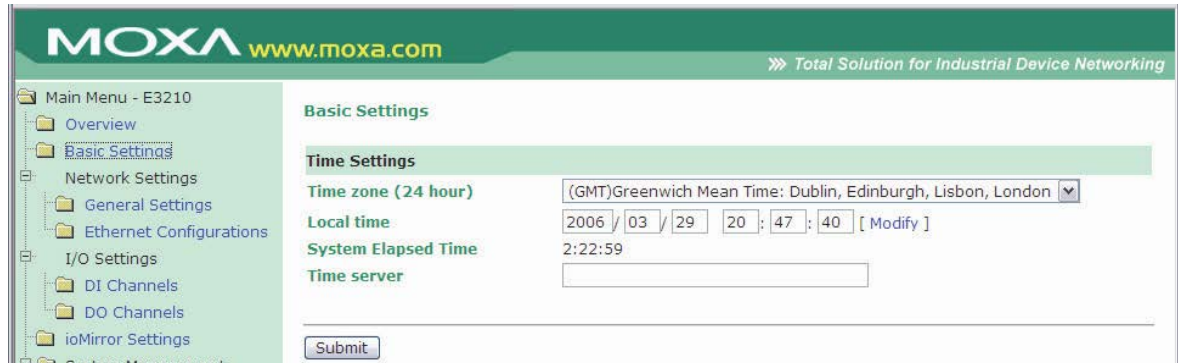

Network Settings

General Settings

On the General Settings page, you may assign a server name and location to assist you in differentiating between different I/O servers.



Ethernet Configurations

On the Ethernet Configurations page, you may assign the IP address, subnet mask, and gateway for your ioMirror server. You may also configure the IP address to be dynamically assigned by DHCP, DHCP/BOOTP, or BOOTP.

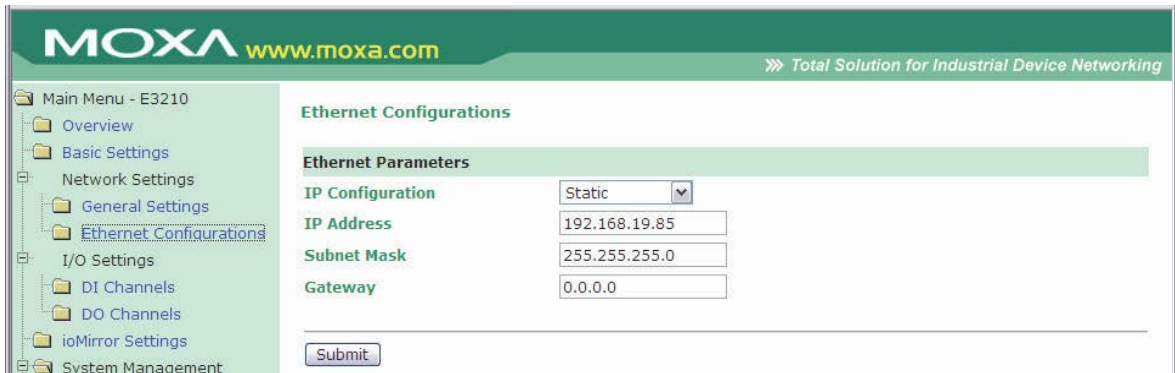

I/O Settings

DI Channels Settings

On the DI Channel Settings page, you may view the status of each DI (digital input) channel. Click a channel to modify the digital input filter.

DI Channel #	Mode	Status	Filter
[DI-00]	DI	Off	0.5 ms
[DI-01]	DI	Off	0.5 ms
[DI-02]	DI	Off	0.5 ms
[DI-03]	DI	Off	0.5 ms
[DI-04]	DI	Off	0.5 ms
[DI-05]	DI	Off	0.5 ms
[DI-06]	DI	Off	0.5 ms
[DI-07]	DI	Off	0.5 ms

The maximum digital input filter value is 65535.

Mode	Filter
DI	1

[* Note]: Filter unit=0.5ms, range=1~65535.

[Warning]! Be sure to Save/Restart your setting.

DO Channel Settings

On the DO Channel Settings page, you may configure each DO (digital output) channel by clicking on the channel.

DO Channel #	Mode	Status
[DO-00]	DO	Off
[DO-01]	DO	Off
[DO-02]	DO	Off
[DO-03]	DO	Off
[DO-04]	DO	Off
[DO-05]	DO	Off
[DO-06]	DO	Off
[DO-07]	DO	Off

The Current Setting sets the channel's current output status in order to test the DO connection. The Power On Setting sets the channel's output status when the I/O server is first powered. The Alarm Status Setting sets the channel's output status when the I/O server is in an alarm state. The alarm is configured on the **ioMirror Settings** page. After changing the DO channel settings, do not forget to Save/Restart your system.

DO Channel #0 Settings

Mode	DO Status
[1. Current Setting] :	
DO	Off ▼
[2. Power On Setting] :	
DO	Off ▼
[3. Alarm Status Setting] :	
DO	Off ▼

[Warning]! Be sure to Save/Restart your setting.

ioMirror Settings

On the ioMirror Settings page, you may configure how I/O signals will be transmitted over Ethernet and how the alarm will operate.

Under ioMirror Settings, **Interval time** determines how often I/O signals will be transmitted and accepts values between 20 and 600,000 ms. **TCP Port no** determines the network port that is used for I/O signal transmission. You can modify this setting as necessary to transmit signals through a firewall. **Time out** determines how long the ioMirror will wait for a network response before it will consider the connection broken.

Alarm Settings

The ioMirror can serve as the input module to several remote output modules simultaneously. At the same time, it can also serve as the output module to other remote input modules. The ioMirror's alarm is designed to activate if any of these connections to other ioMirror units is broken. When the alarm is activated, several things happen:

- all DO channels are reset to their Alarm status.
- the alarm LED flashes if **Blinking Mode** is selected, or displays solid red if **DO Mode** is selected.
- any device connected to the alarm port will be activated based the on **Blinking Mode** or **DO Mode** setting.
- an error message is sent to the ioEventLog.

Under Alarm Settings, you can enable or disable the alarm. You can also specify where and how to send error messages with **ioEventLog Server IP** and **TCP port no**.

Module-to-Module and Channel-to-Channel modes

Module-to-Module mode is used if you wish for all DI channels to be mapped to another ioMirror's DO channels. Simply enter the destination IP address.

Channel-to-Channel mode is used if you wish to individually map DI channels to separate or multiple ioMirror servers. For each DI channel, enter the mapping destination(s) using **Remote Module IP Address** and **Remote DO Channel**. If your ioMirror will also be receiving signals from another ioMirror server, enter the mapping source for each channel using **Acceptable Remote Module IP Address**.

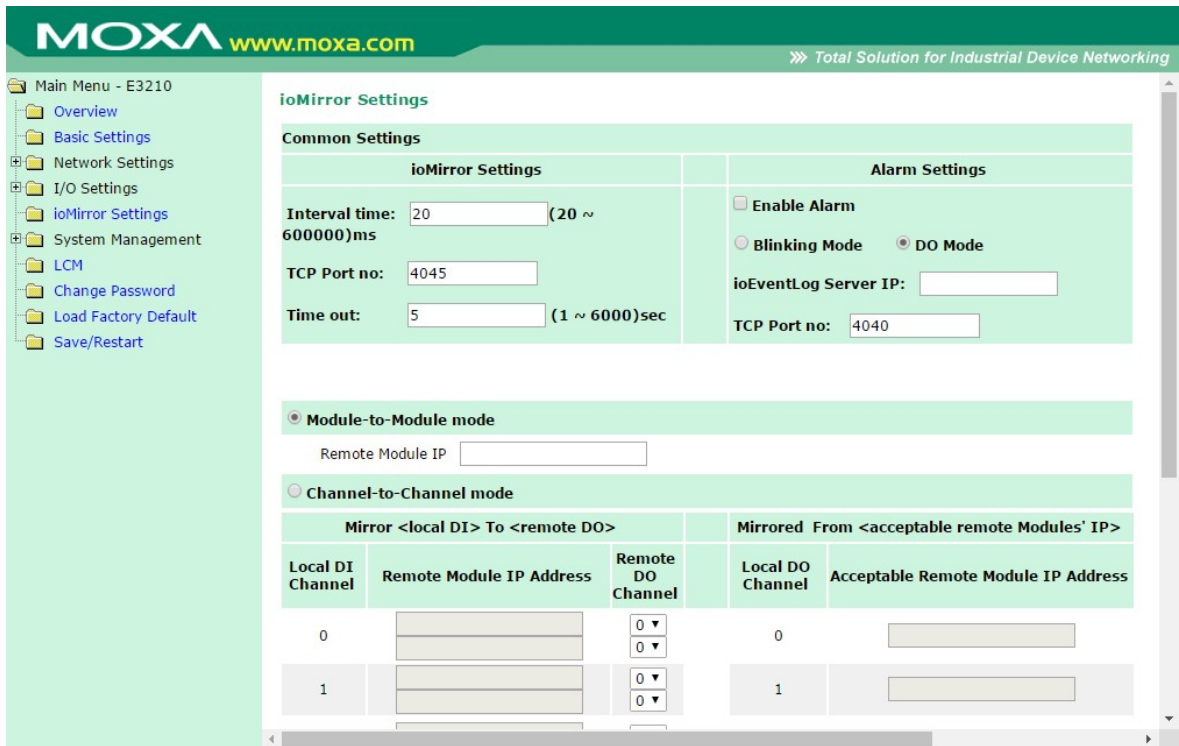

System Management

Accessible IP Settings

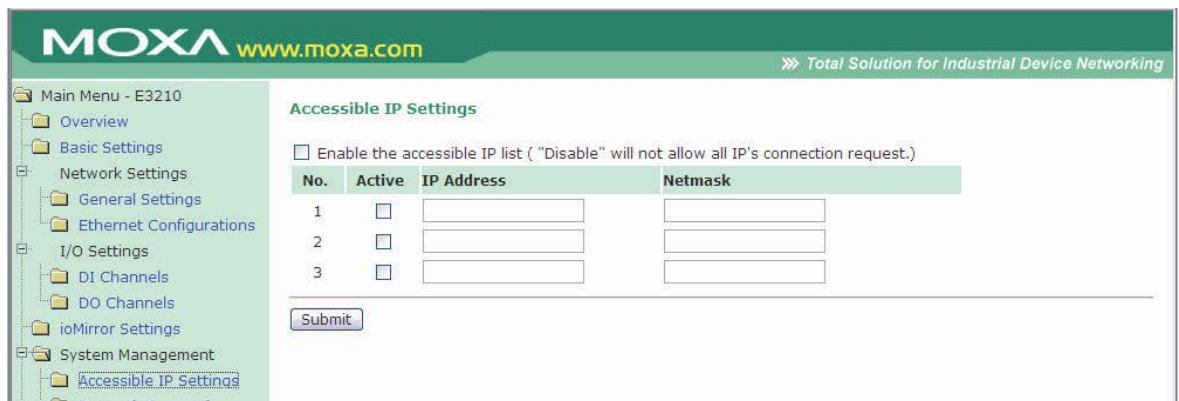

On the Accessible IP Settings page, you may control who has configuration access to the ioMirror by entering the permitted **IP Address** and **Netmask**. When the accessible IP list is enabled, only network hosts on the list may configure the ioMirror. Use the accessible IP list as follows:

- **To grant access to a specific IP address**, use Netmask = 255.255.255.255.
- **To grant access to hosts on a specific subnet**, use a non-trivial Netmask, such as 255.255.255.0.
- **To grant access to any network host**, disable the accessible IP list. You may use the following sample entries for reference:

Desired Hosts	IP Address	Netmask
192.168.1.120	192.168.1.120	255.255.255.255
192.168.1.1 to 192.168.1.254	192.168.1.0	255.255.255.0
192.168.0.1 to 192.168.255.254	192.168.0.0	255.255.0.0
192.168.1.1 to 192.168.1.126	192.168.1.0	255.255.255.128
192.168.1.129 to 192.168.1.254	192.168.1.1	255.255.255.128

Network Connection

On the Network Connection page, you may view each TCP connection, which can make it easier to manage devices and mappings. You also can check which ioMirror units are disconnected for easy debugging.

The connecting protocol for each connection is indicated under Connection Type. Web/HTTP indicates a web console connection to the ioMirror. ioMirror/TCP indicates a connection to another ioMirror unit. For ioMirror connections, Direction is used to indicate whether digital input signals are being transmitted to the remote unit or being received from the remote unit.

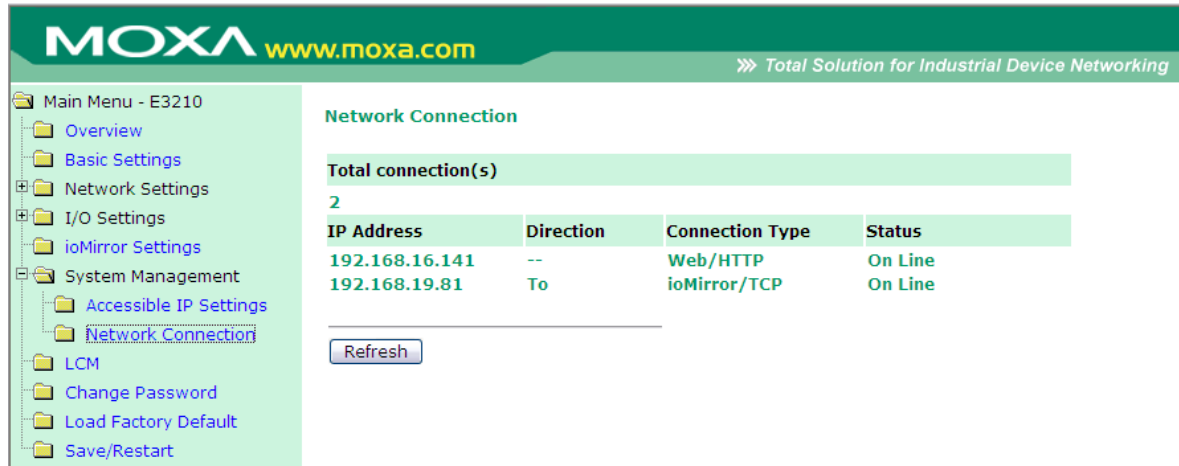

LCM

On the LCM page, you can check the status of the optional LCD display kit. If it is installed successfully, the status will show "Attached" and the firmware details will be displayed.



Change Password

On the Change Password page, you may add or change the password.

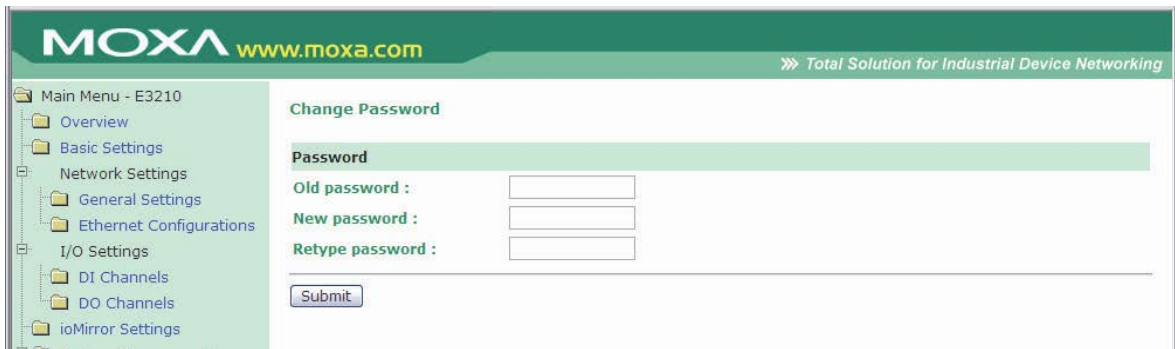

Load Factory Default

On the Load Factory Default page, you may reset the ioMirror back to its factory default settings.

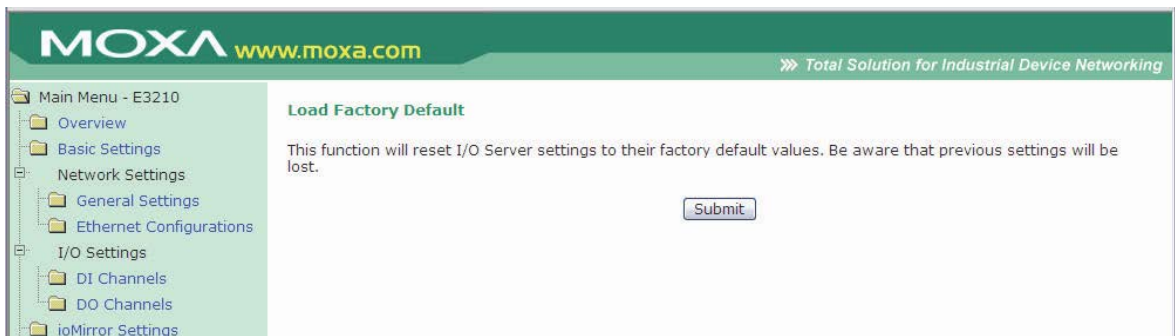

Save/Restart

On the Save/Restart page, you may save all configuration changes and reboot the I/O server with the new configuration.

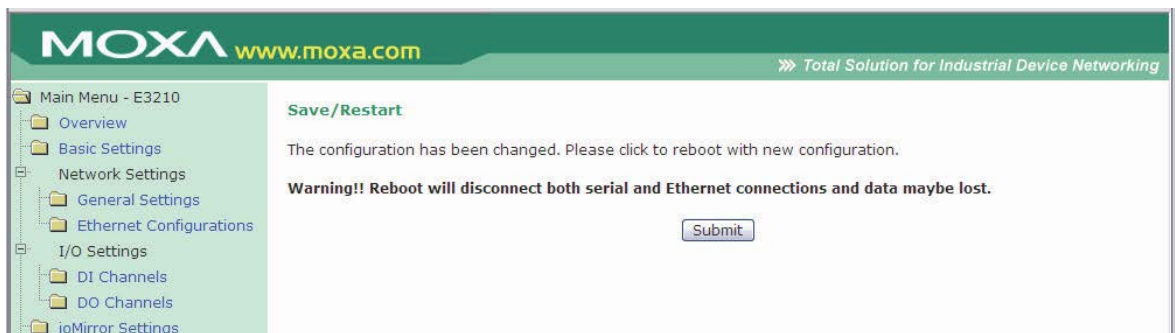

ioMirrorAdmin and ioEventLog

Two Windows utilities, ioMirrorAdmin and ioEventLog, are included to help you manage your ioMirror server over the network.

The following topics are covered in this chapter:

□ **Overview**

□ **Installation**

□ **ioMirrorAdmin**

- Searching for ioMirror Servers
- Wiring Guide
- ioMirror Configuration
- Firmware Update
- Restart System
- Reset to Default

□ **ioEventLog**

- Basic Functions
- Configuration
- Opening Log Files
- Clearing the Log

Overview

Two Windows utilities are provided with the ioMirror E3210.

- **ioMirrorAdmin** allows you to manage your unit over the network. You can configure the unit, upgrade the firmware, or refer to the unit's wiring guide.
- **ioEventLog** receives and stores error messages from ioMirror units on the network.

Installation

To install ioMirrorAdmin and ioEventLog, download the utilities from Moxa's website, double click the installation files, and then follow the installation wizard's instructions to complete the installation. When the installation process is complete, you can open either utility through the Windows Start menu.

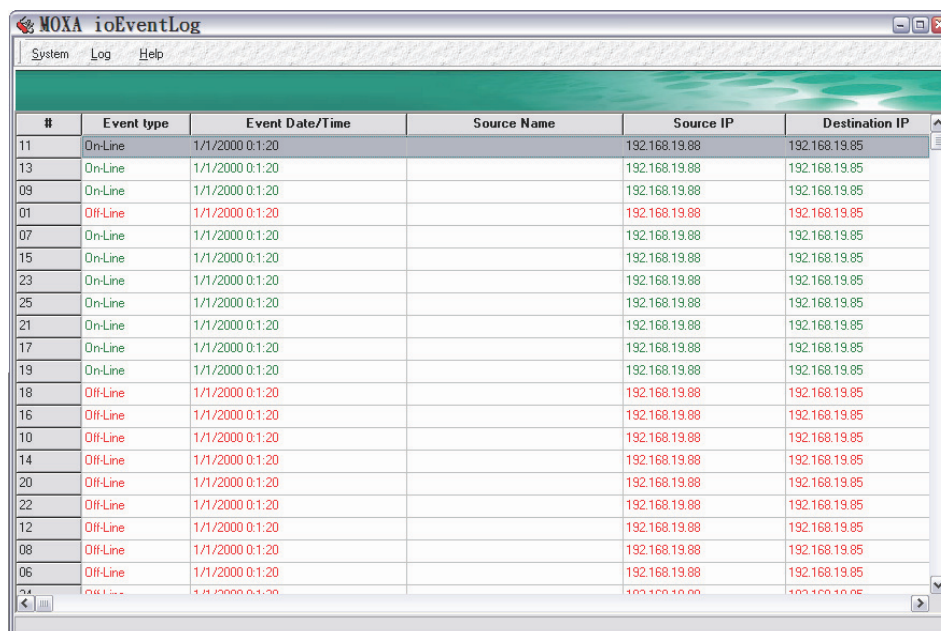
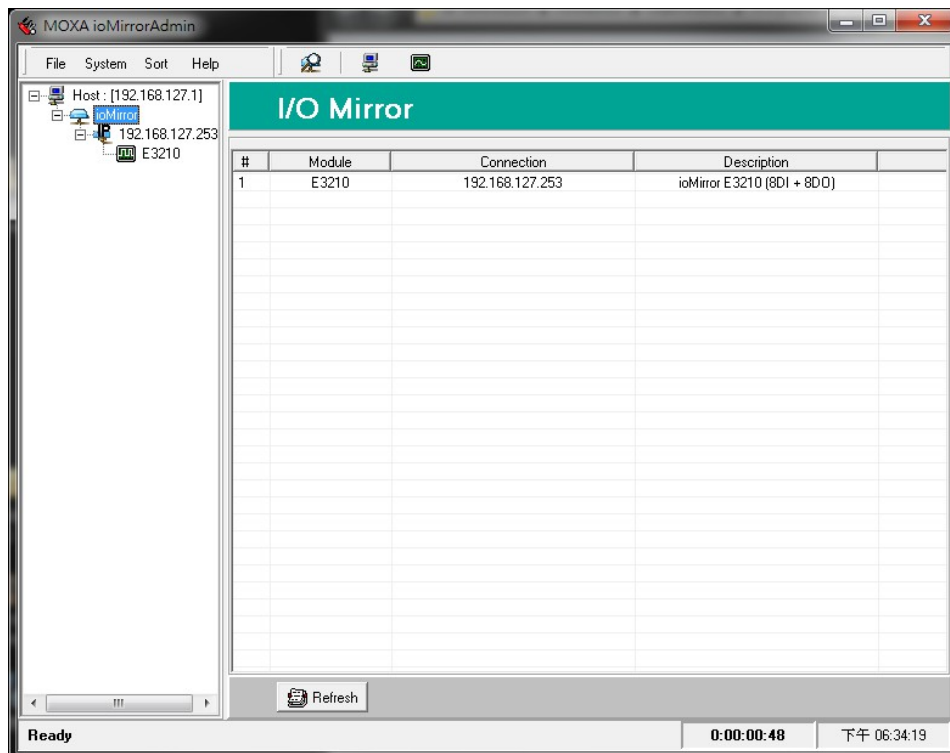

ioMirrorAdmin

Searching for ioMirror Servers

ioMirrorAdmin is designed for network operation. You will need to find your ioMirror unit on the network to use any of ioMirrorAdmin's functions. In the **System** menu, select **Auto Scan Remote I/O Server**. This opens a search window, which automatically searches the network for ioMirror servers.

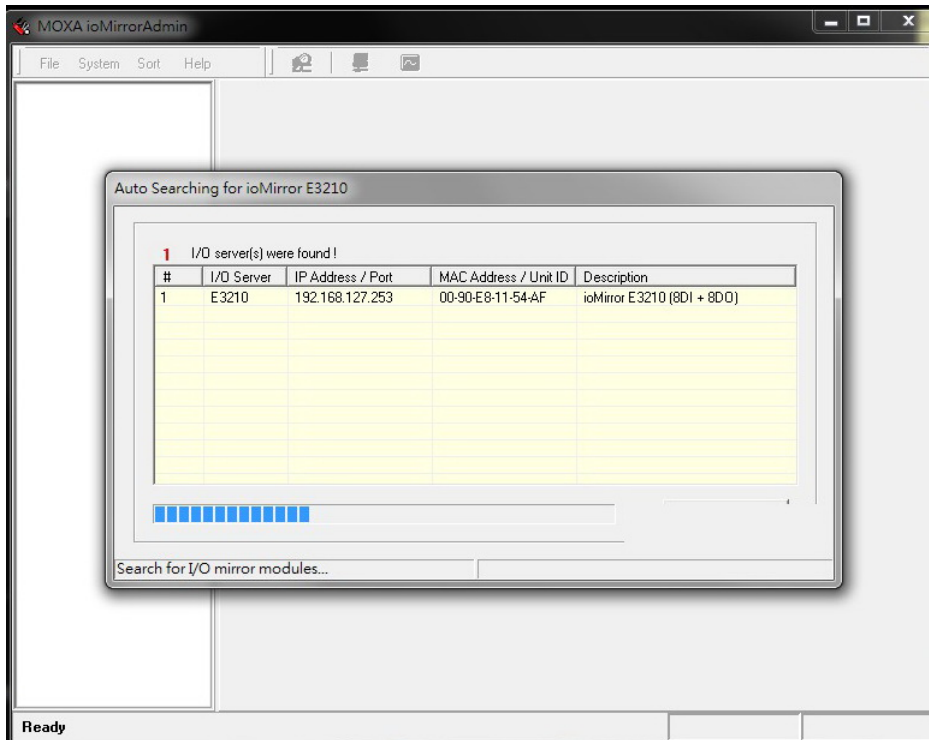

When the search is completed, you will see a list of all ioMirrors. If your ioMirror server is not located, make sure that your computer and your ioMirror server are in the same subnet.

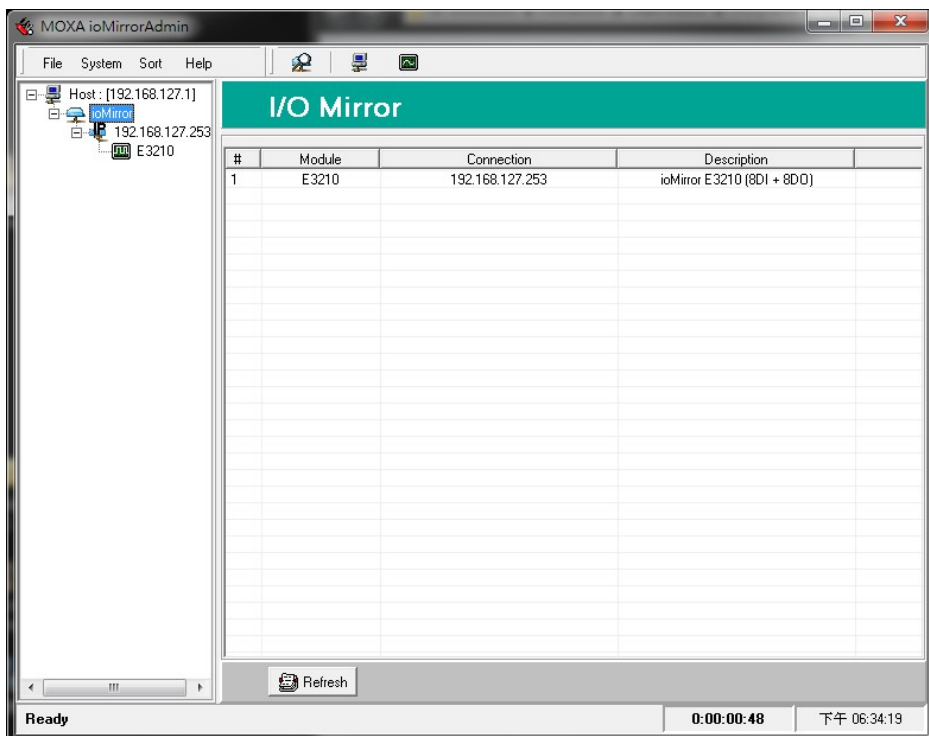

Wiring Guide

To view the ioMirror wiring guide, select Wiring Guide from the Help menu.

E3210 Ethernet Peer-to-Peer I/O, 8 Digital input and 8 Digital output

Ethernet pin assignment

1	TX+
2	TX-
3	RX+
6	RX-

E3210 Wiring Example

(1) Digital Input (Dry Contact)

(2) Digital Input (Wet Contact)

ioMirror Configuration

The ioMirror's web console can be opened within ioMirrorAdmin. Select the desired unit in the left panel. The unit's web console will appear in the right panel. Please refer to Chapter 3 for information on using the web console.

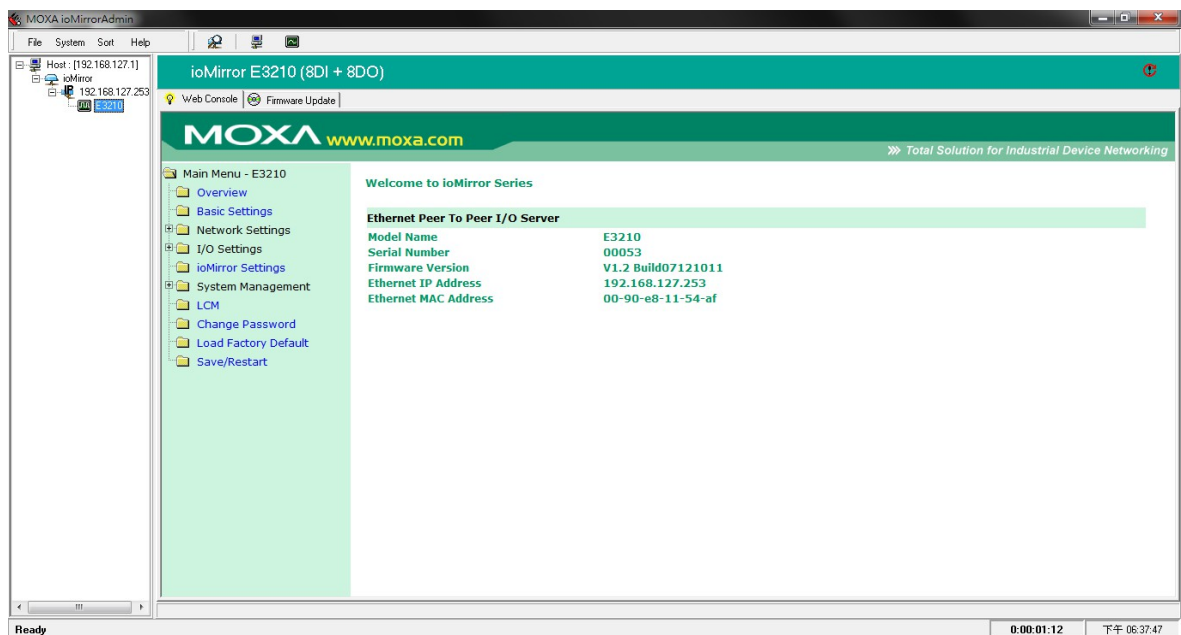

Firmware Update

The ioMirror firmware can be updated through ioMirrorAdmin. Select the desired unit in the left panel. In the right panel, select the **Firmware Update** tab. You may obtain the latest firmware by visiting the Moxa website.

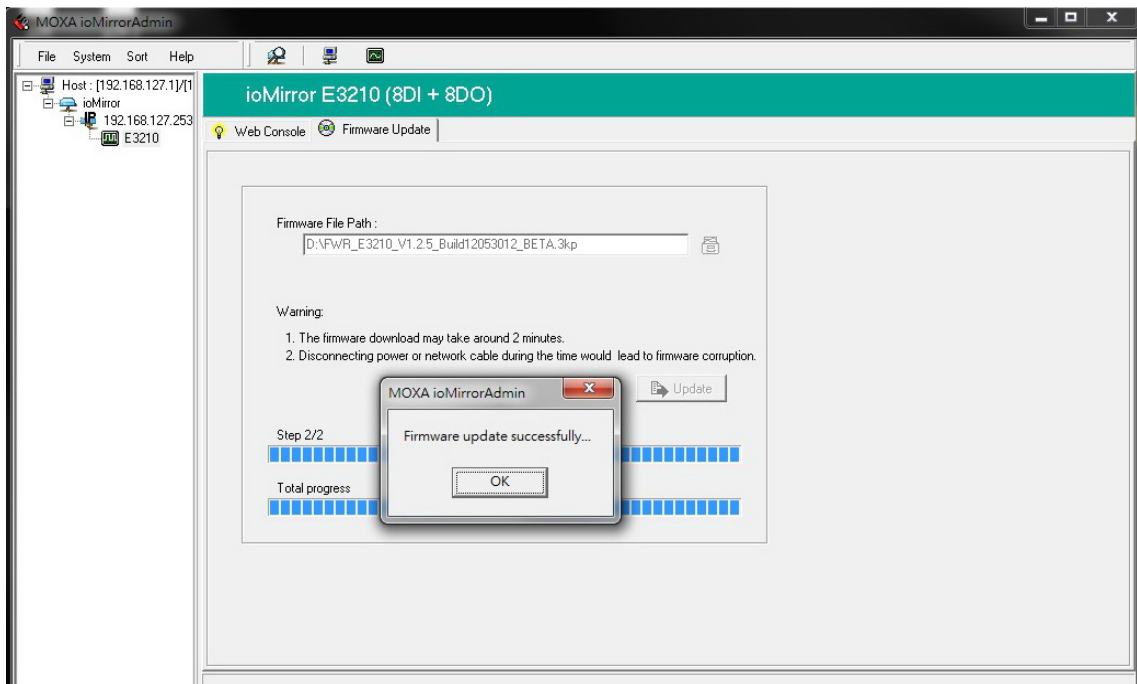

Restart System

You may restart any ioMirror server over the network. Right-click the desired unit in the left panel and select **Restart System**.

Reset to Default

You may load the factory default settings for any ioMirror server on the network. Right-click the desired unit in the left panel and select **Reset to Default**.

ioEventLog

Basic Functions

ioEventLog is designed to help you keep a record of ioMirror status events over the network. The log is stored on the Windows PC, and you will need to set up your ioMirror server to send status events to your PC's IP address. The following events are monitored:

- cold start
- warm start
- off-line
- on-line

For each event, the following information is provided. The log can be sorted by any of these fields:

- event type
- event date and time
- ioMirror source name
- ioMirror source IP
- ioMirror destination IP

Cold start/Warm start

- Cold start: The event will be triggered when the device cold starts.
- Warm start: The event will be triggered when the device reboots.

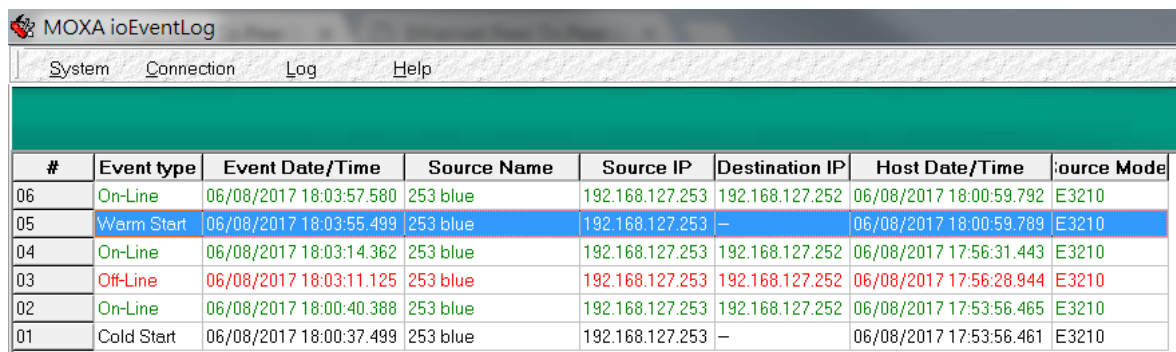

#	Event type	Event Date/Time	Source Name	Source IP	Destination IP	Host Date/Time	Source Mode
06	On-Line	06/08/2017 18:03:57.580	253 blue	192.168.127.253	192.168.127.252	06/08/2017 18:00:59.792	E3210
05	Warm Start	06/08/2017 18:03:55.499	253 blue	192.168.127.253	—	06/08/2017 18:00:59.789	E3210
04	On-Line	06/08/2017 18:03:14.362	253 blue	192.168.127.253	192.168.127.252	06/08/2017 17:56:31.443	E3210
03	Off-Line	06/08/2017 18:03:11.125	253 blue	192.168.127.253	192.168.127.252	06/08/2017 17:56:28.944	E3210
02	On-Line	06/08/2017 18:00:40.388	253 blue	192.168.127.253	192.168.127.252	06/08/2017 17:53:56.465	E3210
01	Cold Start	06/08/2017 18:00:37.499	253 blue	192.168.127.253	—	06/08/2017 17:53:56.461	E3210

Off-line/On-line

- Off-line: The event will be triggered when a peer-to-peer connection has been lost.
- On-line: The event will be triggered when a peer-to-peer connection has been established.

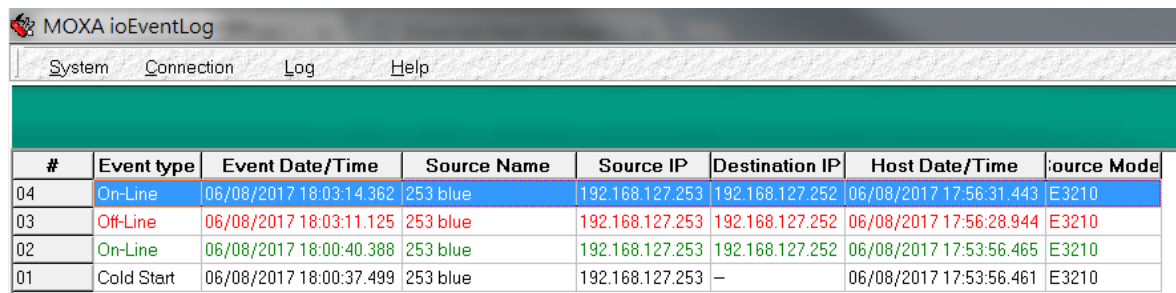

#	Event type	Event Date/Time	Source Name	Source IP	Destination IP	Host Date/Time	Source Mode
04	On-Line	06/08/2017 18:03:14.362	253 blue	192.168.127.253	192.168.127.252	06/08/2017 17:56:31.443	E3210
03	Off-Line	06/08/2017 18:03:11.125	253 blue	192.168.127.253	192.168.127.252	06/08/2017 17:56:28.944	E3210
02	On-Line	06/08/2017 18:00:40.388	253 blue	192.168.127.253	192.168.127.252	06/08/2017 17:53:56.465	E3210
01	Cold Start	06/08/2017 18:00:37.499	253 blue	192.168.127.253	—	06/08/2017 17:53:56.461	E3210

Configuration

In the System menu, select **Settings** to configure ioEventLog.

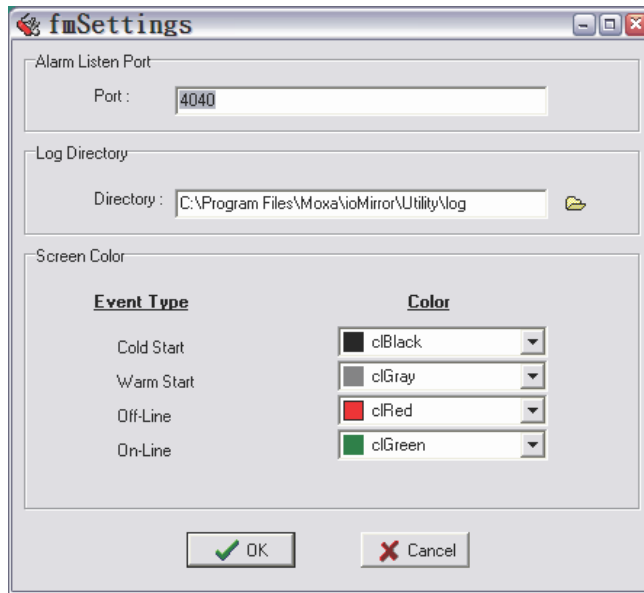

The **Alarm Listen Port** is the TCP port number that will be monitored for status events. You can modify this setting as necessary to receive signals through a firewall. It will need to match the settings for the ioMirror server that is being monitored.

The **Log Directory** is where the log files will be stored. The default directory is **C:\Program Files\Moxa\ioMirror\log**. A separate log file is created for each day, with file names assigned automatically.

You can also select the **Color** for each event type in the log.

Opening Log Files

You can view previously saved logs by selecting **Open** from the Log menu. You will be prompted for the date that you wish to view.

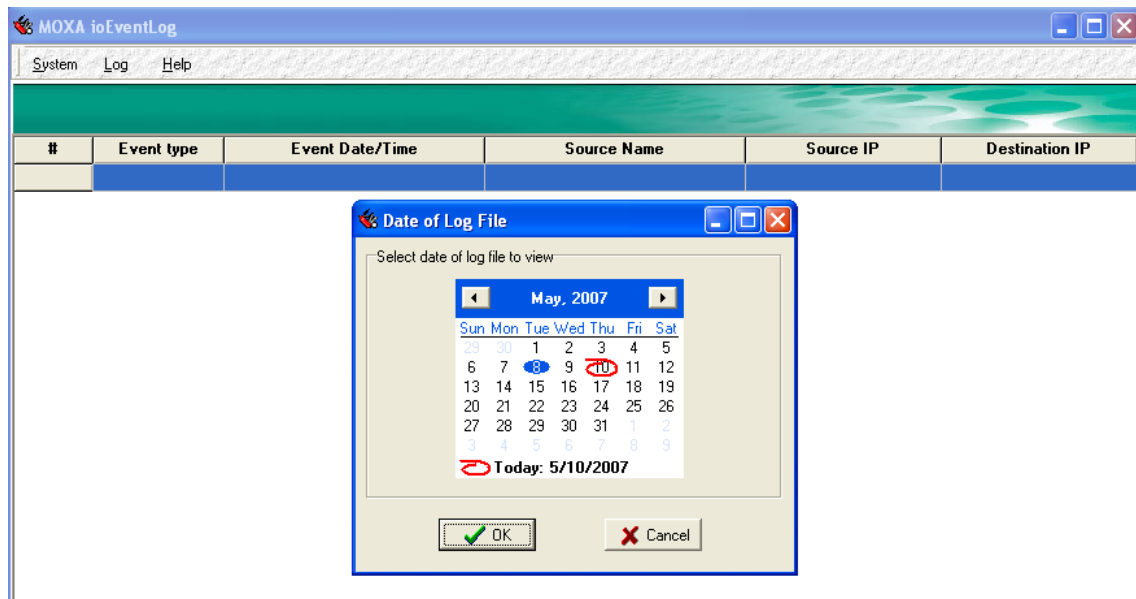

The logs for the day that you select will be displayed in the Alarm Log Viewer window.

#	Event type	Event Date/Time	Source Name	Source IP	Destination IP
01	Warm Start	1/6/2000 6:20:38		192.168.127.253	--
02	On-Line	1/6/2000 6:20:41		192.168.127.253	192.168.127.254
03	Off-Line	1/6/2000 6:19:19		192.168.127.253	192.168.127.254
04	On-Line	1/6/2000 6:19:19		192.168.127.253	192.168.127.254
05	Off-Line	1/6/2000 6:19:22		192.168.127.253	192.168.127.254
06	On-Line	1/6/2000 6:19:22		192.168.127.253	192.168.127.254
07	Off-Line	1/6/2000 6:19:42		192.168.127.253	192.168.127.254
08	On-Line	1/6/2000 6:19:42		192.168.127.253	192.168.127.254
09	Off-Line	1/6/2000 6:20:2		192.168.127.253	192.168.127.254
10	On-Line	1/6/2000 6:20:2		192.168.127.253	192.168.127.254

Reload 10 alarm event(s)

Clearing the Log

If you wish to clear the log, you can select **Clear** from the Log menu. This will clear all events for the current day. The cleared events will not be saved in that day's logs. After the logs are cleared, new events will be displayed and recorded as usual.

LCD Display Kit

The ioMirror supports an optional detachable LCD display kit, also known as the LCM, for easier field maintenance. The LCD display kit is hot-pluggable and can be used to configure the network settings or display other settings.

Controls

The up and down buttons navigate between the current options. The right and left buttons enter and exit the submenus. The center button is used when modifying settings or restarting the server.

Button	Function
Up	go to the previous item
Down	go to the next item
Left	exit the current submenu and return to the previous menu (go up one level)
Right	enter the selected submenu (go down one level)
Center	enter/exit editing mode

An "e" in the upper right hand corner of the display indicates that the parameter can be modified. Press the center button to modify that parameter's settings.

Menu Options

Display	Explanation / Actions
<ioMirror E3210> server	This is the default screen. Enter this submenu to display information about the specific server you are viewing: : <ul style="list-style-type: none"> • serial number • name • location • e3210 f/w ver • lcm f/w ver • model name
<ioMirror E3210> network	Enter this submenu to display information and settings for the network: <ul style="list-style-type: none"> • ethernet link • mac Address • ip mode: Static, DHCP, DHCP/Bootp, Bootp • ip Address: 192.168.127.254 • netmask: 255.255.255.0 • gateway: 0.0.0.0 • dns Server-1: 255.255.255.255 • dns Server-2: 255.255.255.255

Display	Explanation / Actions
<ioMirror E3210> mirror	Enter this submenu to view and set the IP address of the remote output module. This is only for ioMirrors that are operating in Module-to-Module mode: <ul style="list-style-type: none"> • M←_→M IP
<ioMirror E3210> i/o setting	Enter this submenu to view I/O channel status. Here are examples of settings that you might see: <ul style="list-style-type: none"> • di-00 = on • di-07 = 0 Press up or down to navigate through the different I/O channels without having to go back to the previous menu.
<ioMirror E3210> ping	Select this option to enter an IP address to ping. If you get a "timeout" error, it indicates that the unit cannot reach that IP address. Otherwise, the display will show the response time. <ul style="list-style-type: none"> • ip address • ping ip
<ioMirror E3210> save/restart	Enter this submenu to display the restart now submenu. Enter the restart now submenu to display the restart option. Press the center button to modify this option, then select enable to save changes and reboot the ioMirror server. The disable option has no effect.



ATTENTION

Configuration changes that are made through the LCD display kit will not take effect until the unit has been restarted.

B

Modbus/TCP Address Mappings

ioMirror E3210 Modbus Mapping

0xxxx Read/Write Coils (Functions 1, 5, 15)

Reference	Address	Data Type	Description
00001	0x0000	1 bit	CH0 DO Value 0: Off 1: On
00002	0x0001	1 bit	CH1 DO Value 0: Off 1: On
00003	0x0002	1 bit	CH2 DO Value 0: Off 1: On
00004	0x0003	1 bit	CH3 DO Value 0: Off 1: On
00005	0x0004	1 bit	CH4 DO Value 0: Off 1: On
00006	0x0005	1 bit	CH5 DO Value 0: Off 1: On
00007	0x0006	1 bit	CH6 DO Value 0: Off 1: On
00008	0x0007	1 bit	CH7 DO Value 0: Off 1: On
00009	0x0008	1 bit	CH0 DO Power On Value 0: Off 1: On
00010	0x0009	1 bit	CH1 DO Power On Value 0: Off 1: On
00011	0x000A	1 bit	CH2 DO Power On Value 0: Off 1: On
00012	0x000B	1 bit	CH3 DO Power On Value 0: Off 1: On
00013	0x000C	1 bit	CH4 DO Power On Value 0: Off 1: On
00014	0x000D	1 bit	CH5 DO Power On Value 0: Off 1: On
00015	0x000E	1 bit	CH6 DO Power On Value 0: Off 1: On
00016	0x000F	1 bit	CH7 DO Power On Value 0: Off 1: On
00017	0x0010	1 bit	CH0 DO Safe Mode Value 0: Off 1: On
00018	0x0011	1 bit	CH1 DO Safe Mode Value 0: Off 1: On
00019	0x0012	1 bit	CH2 DO Safe Mode Value 0: Off 1: On
00020	0x0013	1 bit	CH3 DO Safe Mode Value 0: Off 1: On
00021	0x0014	1 bit	CH4 DO Safe Mode Value 0: Off 1: On
00022	0x0015	1 bit	CH5 DO Safe Mode Value 0: Off 1: On
00023	0x0016	1 bit	CH6 DO Safe Mode Value 0: Off 1: On
00024	0x0017	1 bit	CH7 DO Safe Mode Value 0: Off 1: On

1xxxx Read Only Coils (Function 2)

Reference	Address	Data Type	Description
10001	0x0000	1 bit	CH0 DI Value, 0=OFF, 1=ON
10002	0x0001	1 bit	CH1 DI Value, 0=OFF, 1=ON
10003	0x0002	1 bit	CH2 DI Value, 0=OFF, 1=ON
10004	0x0003	1 bit	CH3 DI Value, 0=OFF, 1=ON
10005	0x0004	1 bit	CH4 DI Value, 0=OFF, 1=ON
10006	0x0005	1 bit	CH5 DI Value, 0=OFF, 1=ON
10007	0x0006	1 bit	CH6 DI Value, 0=OFF, 1=ON
10008	0x0007	1 bit	CH7 DI Value, 0=OFF, 1=ON

3xxxx Read Only Registers (Function 4)

Reference	Address	Data Type	Description
34097	0x1000 (4096)	1 word	Vendor ID=0x1393
34098	0x1001 (4097)	1 word	Unit ID (Ethernet=1)
34099	0x1002 (4098)	1 word	Product Code=0x2210
38193 to 38264	0x2000 (8192 to 8263)	72 word	Get all DI channels CURRENT status
38265 to 38312	0x2048 (8264 to 8311)	48 word	Get all DO channels CURRENT status
38313 to 38384	0x2078 (8312 to 8383)	72 word	Get all DI channels POWER ON status
38385 to 38432	0x20C0 (8384 to 8431)	48 word	Get all DO channels POWER ON status
38433 to 38504	0x20F0 (8432 to 8503)	72 word	Get all DI channels SAFE MODE status
38505 to 38553	0x2138 (8504 to 8552)	48 word	Get all DO channels SAFE MODE status

4xxxx Read/Write Registers (Functions 3, 6, 16)

Reference	Address	Data Type	Description
40001	0x0000	1 word	Alarm Enable (1: Enable 0: Disable)
40002	0x0001	1 word	ioMirror Alarm Timeout time

Function 8

Address	Function	R/W	Function Code	Length	Description
0x7008 (28680)	F/W	W	16	1 word	Reset existing setting

Used Network Port Numbers

ioMirror E3210 Network Port Usage

Port	Type	Usage
80	TCP	Web Server
502	TCP	Modbus Communication
68	UDP	BOOTPC
68	UDP	DHCP
4045	TCP	ioMirror
4040	TCP	ioEventLog
4800	UDP	Auto search

Factory Default Settings

The factory default configuration for the ioMirror E3210 is as follows:

IP address	192.168.127.254
Netmask	255.255.255.0
Gateway	0.0.0.0
Alarm system	Disable
Time out	5 sec
DI mode	DI
Filter time	0.5 ms
DO mode	DO
DO alarm status	Off
Power on status	Off
Password	NONE
Name	NONE
Location	NONE

Pinouts and Cable Wiring

The following topics are covered in this appendix:

▣ **Port Pinout Diagrams**

- Ethernet Port Pinouts

▣ **Digital I/O Structure**

- Digital Input Structure
- Digital Output Structure
- Alarm Output Structure

Port Pinout Diagrams

Ethernet Port Pinouts

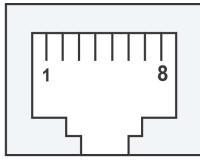

Pin	Signal
1	Tx+
2	Tx-
3	RX+
6	Rx-

Digital I/O Structure

Digital Input Structure

